

Lane Wilson Consulting Services

ARCOM RC210 Alternate Firmware User Manual

RC210 Alternate Firmware User Manual

**Document Identification Number
RC210_AFirmware_UserManual**

2026-02-25

LANE WILSON CONSULTING SERVICES
NELSON, B.C., CANADA. V1L 6X9

Revision History

Revision	Date	Author	Comments
1.1.20	2026-02-25	VE7IHL	RC210 Firmware: Added support to read digital temperature sensors "in the background". This can be used to "fix" a problem where digital temperature sensors data was getting corrupted in the presence of RF energy. (too close to the antenna?) RC210 Config program: Added support for new MACRO function numbers: 708, 709, 730-733.
1.1.19	2025-12-29	VE7IHL	RC210 Firmware: When the internal RSM state goes idle, turn off all Tx PTT lines. Added in special diagnostic (unlocked) DTMF command *21AA9. This command reads out internal variables associated with transmit operation. Added DTMF command: *21AAB and Macro function: 721. These will reset the internal firmware state variables and turn off the PTT/TX lines.
1.1.18	2025-08-06	VE7IHL	RC210 Firmware: Internal fixes done to try to fix occasional problem where Tx was left on.
1.1.17	2025-07-07	VE7IHL	<p>RC210 Firmware: Added additional code to turn off a radio port's TX PTT line every 10 seconds, if it is not supposed to be on. This is an effort to ensure that there are no "stuck" transmitters. Added support for ARCOM RC210 hardware pcb v4.1. Now supports 0-3 DS2433 eeprom chips on the main board. Added DTMF Code (unlocked) diagnostic command: *21AA8 to read the number of DS2433 eeprom chips found. Added support to detect the non-present eeprom chip on ARCOM RTC hardware v4.1 board. DTMF diagnostic commands: *21BB0 - *21BB7 now will detect and say "CRC NOT PERCENT", which actually means the eeprom chip <i>is not present</i>.</p> <p>Fixed problem in RC210 CFG program where Courtesy tone value was not being read/written properly, and it always failed the firmware version check before doing an up/download.</p> <p>RTC Firmware is now v1.0.5. Support for ARCOM RTC hardware v4.1. This version of the RTC does NOT have the AT24C256B memory chip on it. The RTC firmware will still support the AT24C256B eeprom chip if it is found on startup. (<i>this supports older version RTC boards</i>)</p>
1.1.16	2024-10-20	VE7IHL	Attempt to fix the problem when ports are linked and a pending voice ID is done; the user's audio would get cut off.
1.1.15	2024-05-21	VE7IHL	Prepared for vA1.1.15 firmware release. Ability to control Linked ports ID Triggering added.

Revision	Date	Author	Comments
1.1.14	2024-04-27	VE7IHL	Prepared for vA1.1.14 release. Added new diagnostic DTMF commands. Added Digital temperature sensor HIGHEST/LOWEST read/clear support.
1.1.13	2023-11-22	VE7IHL	Prepared for vA1.1.13 release
1.1.12	2023-10-16	VE7IHL	Prepared for vA1.1.12 release
1.1.11	2023-09-05	VE7IHL	Prepared for vA1.1.11 release
1.1.10	2023-08-18	VE7IHL	Prepared for vA1.1.10 release
1.1.9	2023-08-08	VE7IHL	Prepared for vA1.1.9 release.
1.1.8	2023-07-01	VE7IHL	Prepared for vA1.1.8 release.
1.1.7	2023-06-26	VE7IHL	Added note for DTMF diagnostic commands: *21CCcx, *21AA6, and *21AA7. Prepared for vA1.1.7 release.
1.1.6	2023-05-23	VE7IHL	Prepared for vA1.1.6 release
1.1.5	2023-02-05	L. Wilson	Prepared for vA1.1.5 release
1.1.4	2023-01-05	L. Wilson	Prepared for vA1.1.4 release
1.1.3	2022-12-13	L. Wilson	Prepared for vA1.1.3 release.
1.1.2	2022-11-14	L. Wilson	Prepared for vA1.1.2 release. Added RC210 PCB v4.0 support.
1.1.1	2022-11-10	L. Wilson	Prepared for vA1.1.1 release
1.1.0	2022-11-07	L. Wilson	Prepared for vA1.1.0 release

ARCOM RC210 Alternate Firmware User Manual

RC210 Alternate Firmware User Manual

TABLE OF CONTENTS

1.	Introduction.....	8
1.1	Why was this developed?.....	8
1.2	Functional Compatibility with Original ARCOM RC210 Firmware	8
1.3	Hardware Compatibility.....	8
1.3.1	Which Firmware Binary File to Use.....	9
1.4	Current State of the Firmware.....	9
1.5	Differences from ARCOM RC210 Firmware.....	9
1.5.1	RC210 Functional Features Supported.....	10
1.5.2	RC210 Functional Features Not Yet Supported	10
1.5.3	RC210 Functional Features NOT Planned to be Supported.....	10
1.5.4	RC210 NEW Functional Features	11
1.5.5	RS232 Serial Port Protocol (RC210 CFG Tool).....	11
1.5.6	RTC Board Support.....	11
1.5.7	24LC256 Eeprom Board Support	11
1.5.8	Startup and Runtime Error reporting	11
1.6	Macro Support.....	11
1.7	Message Macro Support.....	12
1.8	Release Notes	13
2.	Alternate Firmware Installation.....	21
2.1	Non-Volatile Parameters Full Erase by Version Requirements.....	21
2.2	Save current RC210 Configuration.....	21
2.3	Install Alternate Firmware to the RC210.....	23
2.4	Initial RC210 Configuration	29
2.4.1	Erase all NVM Storage Areas.....	30
2.4.2	Initialize all Parameters	31
2.4.3	Reset RC210	32
2.4.4	Read in all RC210 Parameters.....	32
2.4.5	Save all Parameters to DATA File	33
2.5	Using the RC210 Configuration Tool.....	34
2.6	Prepare DVR Memory Space.....	41
2.7	RTC Board Firmware Update	42
3.	Removal of the Alternate Firmware	44
3.1	Removal of the RTC alternate Firmware.....	44
4.	Runtime Error Detection.....	45
4.1	Configuration Parameter Validation/Startup Indication	45
4.1.1	Validation Results – With RTC/EEP - Hardware Revision 3.5(a)/4.1	45
4.1.2	Validation Results – Without RTC/EEP - Hardware Revision 3.5(a).....	46
4.1.3	Validation Results – With RTC/EEP - Hardware Revision 3.3/4.0	46
4.1.4	Validation Results – Without RTC/EEP - Hardware Revision 3.3/4.0	46

4.2	Successful Startup Indication.....	47
4.3	Unsuccessful Startup Indication.....	47
4.4	Parameter Check Failure Runtime Indication.....	47
4.5	Parameter Check Failure Parameters Missing.....	47
4.6	ARCOM RTC Board Detection.....	47
4.7	External 24LC256 Eeprom Board Detection.....	47
5.	RC210 DTMF Commands Supported.....	48
5.1	Port Configuration (Supervisory) Commands.....	48
5.1.1	Note on setting up DTMF Evaluation On COS/CTCSS Closure.....	49
5.2	Port Linking Commands.....	50
5.3	Auxiliary Audio Inputs.....	50
5.4	General Logic Outputs.....	51
5.5	Extended Logic Outputs.....	51
5.6	Analog Meter Inputs.....	51
5.7	Digital Temperature Sensor Inputs.....	52
5.8	Digital Temperature Sensor I/O Pin Input Selection.....	52
5.9	Digital Temperature Sensor Background Reading Enable.....	52
5.10	Meter Alarms.....	53
5.11	Logic Alarms.....	54
5.12	Davis Instruments Weather Station.....	54
5.13	Remote Base Operation.....	54
5.14	Doug Hall RBI-1.....	54
5.15	AutoPatch Operation.....	54
5.16	Command Macros.....	54
5.17	Macro Subset.....	54
5.18	Startup Macro.....	55
5.19	Message Macros.....	55
5.20	ID Extras.....	55
5.21	ID Extra Special Functions.....	55
5.22	IRLP / Echolink DTMF Regeneration.....	55
5.23	Digital Voice Recorder (DVR).....	56
5.23.1	DVR Recording.....	56
5.23.2	DVR Playing.....	56
5.23.3	DVR Track Erase.....	56
5.23.4	DVR All Tracks Erase.....	56
5.23.5	DVR Track Edit.....	57
5.23.6	Free Recording Time Left.....	57
5.24	General Timers.....	57
5.25	Real Time Clock and Calendar.....	58
5.26	Support for Unlocked Port Commands.....	59
5.27	Unlock Code Programming.....	59
5.28	Pre Command Prefix.....	59
5.29	DTMF Pre Access Code.....	59
5.30	DTMF Pre Access Range.....	59
5.31	Locking (Leaving Program Mode).....	60
5.32	Programming a Custom Lock Code.....	60
5.33	Programming a Custom Terminator Digit.....	60
5.34	Port Timer Programming.....	61
5.35	CTCSS Encode Control Programming.....	61

5.36	Miscellaneous Programming.....	62
5.37	Remote Base Programming.....	62
5.38	Port Inactivity Macro	62
5.39	Command Macros	63
5.39.1	Command Macro Priority	63
5.39.2	Startup Macro	63
5.39.3	Macro Subset (Guest Macros)	63
5.39.4	Determine Contents of a Command Macro	63
5.39.5	Erase Command Macros.....	63
5.39.6	Receiver Macro Functions.....	63
5.39.7	Control Command Macros Accessed by Port.....	64
5.39.8	Message Macros	64
5.39.9	Speech Control Within Command Macros.....	64
5.39.10	Macro Function Number List	65
5.40	Keyup Counter and Activity Timers	71
5.41	RSSI (signal strength) Reporting	71
5.42	Tail Messages.....	71
5.43	DTMF Memories	71
5.44	DTMF Digits Duration and Time Between Digits.....	71
5.45	IRLP / Echolink DTMF Regeneration	71
5.46	Scheduler.....	72
5.47	Voice IDs	73
5.48	ID Extras	73
5.49	ID Extras Special.....	73
5.50	Enable/Disable Voice IDs	73
5.51	Selecting ID Timer Start	74
5.52	Constant ID	74
5.53	CW IDs	74
5.54	CW Speed Programming.....	74
5.55	CW Tone Programming.....	74
5.56	CW ID Programming	74
5.57	Using the Digital Voice Recorder (DVR).....	74
5.58	Resetting the RC210	75
5.59	Using the Yaesu DR-1X Fusion Repeater	75
5.60	NVM Parameters Erase/Reset.....	76
5.61	Startup NVM Test Results	76
5.62	Internal Firmware Debugging Information	77
5.63	Hardware Setup Supporting Commands.....	78
5.64	Courtesy Tone Programming.....	78
5.65	Programming Meter Faces – 10-bit A/D Converters	79
5.66	Programming Meter Alarms	79
5.67	Programming Reference Voltage.....	79
5.68	Alarm programming.....	79
5.68.1	Which Macro to Use with an Alarm.....	79
5.69	Special Diagnostic DTMF Commands	80
6.	DTMF Pre-Access Code & Range Discussion.....	82
7.	Linked Ports & Triggered IDs Discussion.....	82

8.	Configuration parameter Storage Allocation map.....	83
8.1	RC210 Hardware Version Eeprom Storage Capabilities.....	83
8.2	Configuration Parameter Allocation Map.....	84
9.	DVR VOICE Vocabulary List.....	86
10.	Factory Default Programming Values.....	89
11.	LM335 Analog Temperature Sensor Connection.....	90
12.	Digital Temperature Sensor Support.....	91
12.1	Ready Made DS18B20 Temperature Sensors Available.....	92
13.	Optional 24LC256 Eeprom Board.....	93
13.1	RC210 Hardware Modification.....	93
13.2	24LC256 Eeprom Board Schematic.....	93

LIST OF FIGURES

NO TABLE OF FIGURES ENTRIES FOUND.

LIST OF TABLES

Table 1 – Macros Supported.....	11
Table 2 – Message Macros Supported.....	12
Table 3 –Front Panel Configuration Validation with RTC/EEP & DS2433s.....	45
Table 4 –Front Panel Configuration Validation without RTC/EEP but with DS2433s.....	46
Table 5 –Front Panel Configuration Validation with RTC/EEP without DS2433s.....	46
Table 6 –Front Panel Configuration Validation without RTC/EEP without DS2433s.....	46
Table 7 – Voice ID Extras.....	55
Table 8 –ISD4003 Voice Record IC Time Segment Types.....	57
Table 9 – RC210 Hardware Versions Eeprom Devices Supported.....	83
Table 10 – Configuration Parameters Allocation Map.....	85

1. INTRODUCTION

The document describes the RC210 *Alternate* firmware. This replacement firmware was written by VE7IHL and only implements a subset of the original ARCOM written firmware functionality.

1.1 Why was this developed?

This firmware was developed by VE7IHL to be used on the RC210 controllers used by repeaters owned/managed by the West Kootenay Amateur Radio Club (WKARC) located in Nelson, BC, Canada. It is not meant to be a full functional replacement of the original ARCOM RC210 firmware, only to have sufficient features to provide basic repeater operations.

The design of the firmware has been done to make the RC210 firmware *robust* in operation, and in configuring it using the replacement Windows RCP Configuration program. Several problems have occurred where the RC210 internal non-volatile parameters get “*corrupted*” resulting in incorrect operation. This firmware has redundant non-volatile parameters copies (with an internal recovery procedure) of all the programming parameters stored in additional eeprom space located on the RTC board.

Internally the firmware uses Event-Driven real-time design concepts to maintain accurate internal timing. A Real-Time-Operating-System (RTOS) is used as the basis of the firmware design.

One of the design goals was to be able to reduce standby power consumption by putting the 2561 MCU, the DVR voice recorder chip, and the optional RTC board MCU to sleep when no repeater activity is present. As of firmware vA1.06 a reduction of about 50% has been achieved. This will make the RC210 more suitable for solar powered repeater systems.

1.2 Functional Compatibility with Original ARCOM RC210 Firmware

The alternate RC210 firmware is compatible with the (*a limited sub-set is supported*) DTMF commands. The alternate firmware can be loaded into the RC210 board using the RS232 serial port and the ARCOM supplied Windows tool: *Arcom 2561 Updater*.

1.3 Hardware Compatibility

This firmware has been developed and tested on a RC210 Rev 3.5(a) board. Starting with firmware version 1.1.2, there is a firmware binary file for the RC210 Rev 4.0 board. Starting with firmware version 1.1.17, there is support for RC210 Rev 4.1 board. The firmware starting with v1.03 has been written so it will run on RC210 boards that do not have the three DS2433 eeprom devices installed. It may run on older RC210 boards that have the older ATMEGA128 controller chip on the, but this has not yet been tested.

1.3.1 Which Firmware Binary File to Use

RC210 Hardware Revision	Firmware File to use
4.0	RC210V40_FW_AvX.X.X.Bin <i>replace X.X.X with the current Alternate firmware version file in use</i>
3.5x and 4.1	RC210_FW_AvX.X.X.Bin <i>replace X.X.X with the current Alternate firmware version file in use</i>

1.4 Current State of the Firmware

As of February 25, 2026, vA1.1.20 of the alternate RC210 firmware can be used on all RC210 controller boards that are supported.

This firmware is not yet complete and will only ever contain a subset of the functionality of the ARCOM written RC210 firmware. It is meant to have a reduced functional set of features, while containing robustness and error detection features.

Please report issues and problems to Lane VE7IHL.

New versions of this firmware will continue to be developed until it is considered complete and in a functional state for the WKARC repeater usage. Time frame for this to be completed is summer 2026.

1.5 Differences from ARCOM RC210 Firmware

Area:	Description:
Non-Volatile Configuration Parameters	Stored using an error checking method (16-bit CRC) to ensure that the configuration parameters are valid. If the RTC board is installed, and its firmware has been updated, then the eeprom data space on the RTC board will be used hold <i>Backup</i> copies of the configuration parameters. Automatic recovery if possible is performed on power up.
RS232 Serial Communication to PC Functionality	Uses a binary protocol (DF1) to detect communication errors. Will retry the communication automatically if an error was detected. Limited sub-set of the ARCOM firmware's functionality. See following document sections for what is supported.
RTC (Real Time Clock)	Requires new/changed firmware to be installed on the RTC board. (Can be run without the RTC board) Uses an error checking simplified DF1 serial protocol.
Windows Configuration Tool	Uses a different Windows program to configure the Alternate RC210 firmware. Currently only tested under Windows 10.
Visual Status Indication on Startup	When the Alternate RC210 firmware starts up, the 6 front panel LEDs (COS and CTCSS) will indicate conditional status of the firmware: NVM Parameters are OK or BAD ARCOM RTC board is present or not.

1.5.1 RC210 Functional Features Supported

The supported functional features are listed below (some only supported via the RCP configuration program):

- CFG Serial Port Protocol (*new DF1 binary protocol used*)
- Basic Repeater Configuration
- Command Macros
- Message Macros
- Voice and CW IDs
- Tail Messages
- Timers
- RTC (*with new firmware installed*)
- Courtesy Tone Programming
- Port Linking
- I/O Support (Analog and Digital)
- General Logic Outputs
- Alarms, all types
- Firmware Updating
- DVR support
- Scheduler
- DTMF Memories

For a more detailed description of each supported (DTMF) commands, consult the ARCOM manual: *RC210 Repeater Controller Operations and programming Manual*.

1.5.2 RC210 Functional Features Not Yet Supported

- Auxiliary Audio inputs
- Key up Counter and Activity Timers

1.5.3 RC210 Functional Features NOT Planned to be Supported

The following functional areas are **not planned to be** supported by the alternate RC210 firmware:

- AutoPatch
- Davis Instruments Weather Station
- Remote Base Operation
- Doug Hall RBI-1
- Extended Logic Outputs
- RSSI Reporting
- Original RCP Serial protocol

1.5.4 RC210 NEW Functional Features

The following are new features that do not exist in the original ARCOM RC210 firmware:

- Special features added to Voice ID Extras: Reporting of NVM Parameter status: Good, Failed, Recovered, and Restored.
- Additional DTMF commands added for NVM storage validity reporting; erase and set to Factory Defaults.
- Support for the digital temperature sensors: DS18B20 and MAX31820. Requires a custom hardware logic interface PCB.
- Support for an eeprom memory board in place of the ARCOM RTC option board.

1.5.5 RS232 Serial Port Protocol (RC210 CFG Tool)

The alternate RC210 firmware uses a different serial protocol to detect any possible communication errors. This is a binary protocol based on the DF1 protocol.

1.5.6 RTC Board Support

The RTC board is supported but currently requires new firmware to be loaded into it. At this time (Nov/2022) there is no *easy user* method to load the RTC firmware via the RC210's serial port. It must be loaded using an AVR device programmer connected to the 10-pin programming connector. More details on how to do this will be available later.

1.5.7 24LC256 Eeprom Board Support

This is a custom eeprom board that can be used in place of the ARCOM RTC board. It only provides the backup configuration parameter support, and does NOT provide real time clock support. Its advantage is a lower standby current draw than the RTC board.

1.5.8 Startup and Runtime Error reporting

The internal non-volatile parameters are checked on startup to ensure that they are present, their values are correct, intact, and have not been corrupted. See the section on runtime error detection for more details.

1.6 Macro Support

The table below shows how many MACROs and what hardware is required to support them:

Macro Type:	Number Range:	Hardware Required:
Long	1 – 40	Base RC210 board
Short	41 – 50	Base RC210 Board
Short	51 - 90	DS2433 EEPROMs installed.

Table 1 – Macros Supported

1.7 Message Macro Support

The table below shows how many MESSAGE MACROs and what hardware is required to support them:

Number Range:	Hardware Required:
1 – 40	Base RC210 board
41 – 70	DS2433 EEPROMs installed

Table 2 – Message Macros Supported

1.8 Release Notes

Version:	Changes / Notes:
1.1.20	<p>RC210 vA1.1.20 firmware, RTC V1.05 firmware, RC210_CFG program v1.1.20</p> <p>RC210 FW: Added new macro functions 708, 709: Enable/Disable background digital temperature reading. Added new DTMF commands: 14301 = Enable, 14300 = Disable background digital temperature reading. Added new DTMF commands: 1410(1-4)3 to read back current/previous digital temperature sensor values. Added support for internal MACRO (numbers) 730-733. These will read out the previously "read" digital temperature sensor value(s). The digital temperature sensors are now read out once per minute.</p> <p>RC210 CFG Tool: Added support for new Macro function numbers: 708, 709, 730-733.</p>
1.1.19	<p>RC210 vA1.1.19 firmware, RTC V1.05 firmware, RC210_CFG program v1.1.19</p> <p>RC210 FW: When the firmware goes idle (after 60 seconds no activity), force all active Transmitter port's PTT lines false (OFF). Added in special diagnostic command: (unlocked) *21AA9. This speaks out 3 sets on internal variables related to the PPT (Transmit) operation. Added DTMF command: *21AAB and Macro function: 721. These will reset the internal firmware state variables and turn off the PTT/TX lines.</p> <p>RC210 CFG Tool: No functional changes.</p>
1.1.18	<p>RC210 vA1.1.18 firmware, RTC V1.05 firmware, RC210_CFG program v1.1.18</p> <p>RC210 FW: Added internal changes to try to fix the problem where occasionally the transmit PT) line was left on.</p> <p>RC210 CFG Tool: No functional changes.</p>
1.1.17	<p>RC210 vA1.1.17 firmware, RTC V1.05 firmware, RC210_CFG program v1.1.17</p> <p>RC210 FW: Added additional code to turn off a radio port's TX PTT line every 10 seconds, if it is not supposed to be on. This is an effort to ensure that there are no "stuck" transmitters. Added support for ARCOM RC210 hardware PCB v4.1. Now supports 0-3 DS2433 eeprom chips on the main board. Added DTMF Code (unlocked) diagnostic command: *21AA8 to read the number of DS2433 eeprom chips found. Added support to detect the not-present eeprom chip on ARCOM RTC hardware v4.1 board. DTMF diagnostic commands: *21BB0 - *21BB7 now will detect and say "CRC NOT PERCENT", which actually means the eeprom chip <i>is not present</i>.</p> <p>RC210 CFG Tool: Fixed problem in RC210 CFG program where Courtesy tone value was not being read/written properly. Fixed problem where it always failed the firmware version check before doing an up/download.</p> <p>RTC FW: Support for ARCOM RTC hardware v4.1. This version of the RTC does NOT have the AT24C256B memory chip on it. The RTC firmware will still support the AT24C256B eeprom chip if it is found on startup. (<i>this supports older version RTC boards</i>)</p>
1.1.16	<p>RC210 vA1.1.16 firmware, RTC V1.04 firmware, RC210_CFG program v1.1.16</p> <p>RC210 FW: Attempt to fix the problem when ports are linked, and a pending voice ID is performed, and there was an existing linked transmit occurring (from the linked port) the incoming (linked port audio) would get cut off. Now the voice ID can still be heard faintly, but the initial voice (audio) is not cut off.</p>
1.1.15	<p>RC210 vA1.1.15 firmware, RTC V1.04 firmware, RC210_CFG program v1.1.15</p> <p>RC210 FW: Added support to control ID Triggering (sending out of configured port IDs) when using linked ports. Added support for RC210 CFG tool to read/write the new global parameter: "Linked ports ID Trigger On/Off". Now have the following configuration options for this On/Off setting: from the RC210CFG tool, from the RC210 internal firmware Macro numbers: 719 (Turn ON), and 720 (Turn OFF), and from the unlocked state: DTMF codes: *20911 (Turn ON) and *20912 (Turn OFF).</p>

1.1.14	<p>RC210 vA1.1.14 firmware, RTC V1.04 firmware, RC210_CFG program v1.1.14 RC210 FW: Added support to read any/all configured digital temperature sensors every 10 minutes. This is used to keep a running track of a digital temperature sensor's HIGHEST and LOWEST values. Added support to read/save digital temperature HIGHEST and LOWEST values into ram. Added new MACROS: 704-707, 715-718, 570-585. Now have unlocked DTMF command support (and the higher-level macro support) to read all analog & digital temperature values: Current, Highest, and Lowest values. The HIGHEST and LOWEST values are only saved in ram and will be reset on a power-up or firmware reset. Added port unlocked DTMF command: 1555, 2555, and 3555 that will key up a single Port's (1, 2, or 3) transmit and leave it keyed up. This is for testing transmit timeout timers (hardware timers) that are present in DE/Codan electronics. Any COS activate (key-up) on any port will cancel and turn off the Tx.</p>
1.1.13	<p>RC210 vA1.1.13 firmware, RTC V1.04 firmware, RC210_CFG program v1.1.13 RC210 FW: Fixed problem where if an Initial ID was playing in CW, and the user keys up, no audio would get transmitted (over-top of the CW). This applied to a linked port keying up too. Additional attempts to fix stuck Transmit problem. Interrupt protection added to some areas of the code to ensure integrity of the operation. The radio state machine's code used to stop transmit has been changed to better support operation from a linked radio port. Fixed a problem where the Initial ID when using CW mode instigated from a linked port would sometimes play at a lower audio volume. Fixed a problem where when the Initial ID (played in CW) started from a linked port would sometimes get 2 sets of Courtesy Tones played. Changed the (MCU) Fatal error handler to always/eventually reset the CPU after displaying the fatal error code on the LEDs. Changed stuck Transmit monitor detection code to delay 5 seconds instead of the previous 10 seconds. Fine tuning of the stuck transmit monitoring code. Attempting to fix problem where a repeater's transmit was shut off when it should have been left on.</p>
1.1.12	<p>RC210 vA1.1.12 firmware, RTC V1.04 firmware, RC210_CFG program v1.1.12 RC210 FW: Minor fix, COS/PLIN debounce code may not have worked on radio port 3. Fixes for "stuck transmitter" problem: The stuck tx watchdog code is now enabled by default on start-up. (Can still be controlled ON/OFF via macro functions 710/711). When starting to stop a linked port's tx, if it cannot be stopped right away, it will be delay stopped (always). This will add a typical .5 second in turning off the linked port's tx. Found cause of stuck tx, was missing turning off an internal software flag that was indicating an Initial/pending ID was being sent.</p>
1.1.11	<p>RC210 vA1.1.11 firmware, RTC V1.04 firmware, RC210_CFG program v1.1.11 RC210 FW: Added new DTMF (when unlocked) commands: *2050 xxx yyyyyyy . Used to write in MACRO DTMF command code. *4002 <Macro#> * MacroFunc#> * <MacroFunc#>... *4008x. Reads back the contents of a command MACRO. *4003x. Erase a command macro. *2103 <MSG#><MSGVW><MSGVW>... up to 9 words. Message macro write command. Ensure each vocab word uses full 3 digits. *31CT, *32CT, *33CT, and *34CT. Supports programming the Courtesy Tones (1-10) *1017xy and *2092xy. Support for General Timers</p> <p>Added support to track the number of hours the RC210 has been running (without a reboot). The number of hours running is only valid as long as the RC210 does not get reset, or a power failure occurs. Added unlocked diagnostic DTMF command: *2222 that will report the number of hours it has been running. Added new Macro function: 714 that will say/report the number of hours the RC210 has been running. Changed stuck Transmit watchdog code to wait up to 60 seconds (was previously 2 seconds) before trying to turn off a radio port's transmit.</p> <p>RC210_CFG: Added new Macro function: 714 to internal macro list.</p>
1.1.10	<p>RC210 vA1.1.10 firmware, RTC V1.04 firmware, RC210_CFG program v1.1.10 RC210 FW: Added new MACRO commands: 712 and 713. 712 can be used to enable the Tx Fan operation, and 713 can be used to disable the Tx Fan operation. When using these macro commands, ensure they are placed at the start of MACRO definition (put them first). Fixed some logic problems with activating the Tx Fan, when audio is played from a macro and not from a COS started repeater operation. This change has been done to support the ability of disabling the tx fan when a low power, and/or AC power failure condition has been detected by the RC210 firmware. (via another RC210 input). Removed the previously added code that tried to compensate for the analog channel inline 470 ohm resistor on the analog temperature channel.</p>

	RC210_CFG: Added support for new Macro functions: 712 and 713 .
1.1.9	<p>RC210 vA1.1.9 firmware, RTC V1.04 firmware, RC210_CFG program v1.1.9</p> <p>RC210_FW: The "extra" stuck transmit checking code is now disabled by default on reset/power-up. It can be enabled/disabled via unlocked DTMF command: *21BB9, or via new MACRO commands 710 (Enable stuck TX watchdog support), and 711 (Disable stuck TX watchdog support). Fixed problem where the DVR chip's power was turned off, even if there was a DVR play operation in progress. This would result in the DVR audio being shut off at random times. Should fix a known problem when a macro running from a general timer was executing a speaking voice macro, and it would get terminated prematurely. Fixed a minor problem where the internal running of the scheduler would keep the radio State machine not going idle. The code to check for a "stuck" transmit has been simplified and improved. The previous code that would run checking for a stuck Tx once the RSM when idle (after 60 seconds of no RSM change) has been removed, as if it did not check for any valid radio port input conditions. The existing stuck tx port code will now wait for 10 seconds before turning off the tx on a suspected stuck tx condition. If the port's input (COS/PLIN and linked port input) changes during the 10 second wait time, then the stuck tx turn-off is cancelled.</p> <p>RC210_CFG: Fixed/Improved several problems with serial (DF1 protocol) communications. Shortened DF1 response wait timeouts to about 510 msec. The DF1 driver will now try up to 3 times to send the initial request message before giving up. The RC210_CFG will now wait about 10 seconds before internally closing its serial port connection, which in turn will reduce CPU usage. These improvements fix the problem of sometimes not being able to read the RC210 firmware version. Fixed problem where you could not store a "ZERO" (to be used as a spoken "0") into a Message macro. Fixed problem where if a parameter was changed/saved, and then parameter screen was displayed again, and then a CANCEL was pressed, the previous "pending" parameter download was also cancelled. The RC210_CFG program now internally keeps 2 sets of "pending" flags for each parameter, so that it can know/remember if a parameter was actually changed. Fixed a problem where if you uploaded all parameters from the RC210, and then tried to view them, they would get over-written either by their defaults (if no data file was open), or by the parameters stored in the specified/open data file. Now, you will be able to view/change the RC210 parameters that have been read in from the RC210 over the serial port. A Warning is issued to the user after the all parameter download is completed, stating that you will need to save these just read in parameters to a data file.</p>
1.1.8	<p>RC210 vA1.1.8 firmware, RTC V1.04 firmware, RC210_CFG program v1.1.8</p> <ul style="list-style-type: none"> • RC210_FW: When using the Macro to start a General Timer, set the general timer counter value to its initial (starting) value. Fixed the General Timer Macro # being incorrectly loaded from the RC210_CFG program (was off by 1). • RC210_CFG: Added user option to ignore/not check the RC210 firmware version before reading/sending configuration parameters. General Timer(s) MACRO # is now stored in the .INI file as the actual value, and not an index value.
1.1.7	<p>RC210 vA1.1.7 firmware, RTC V1.04 firmware, RC210_CFG program v1.17</p> <ul style="list-style-type: none"> • Optimized the RC210 firmware to check for stuck Tx and this feature is now defaulted to be enabled. • Added diagnostic DTMF command: *21CCCx where x = 1 - 8 meaning which analog meter face channel to read/calculate the actual analog voltage at the port pin. Useful when trying to calibrate an analogue input channel being used for example, when reading battery voltage. Helps you setup the 4 configuration parameters in RC210 CFG program. • Added new diagnostic command *21AA6 which will read back the RTC firmware version number. • Added new diagnostic command *21AA7 which will read-back the RC210 firmware version number.
1.1.6	<p>RC210 vA1.1.6 firmware, RTC V1.04 firmware, RC210_CFG program v1.16</p> <ul style="list-style-type: none"> • RC210_CFG: Changes to Courtesy Tone page: No longer sets pending writes if operation was cancelled. Fixed operation of the "Scheduler/Clock" page: You can now change values among multiple scheduler set points, and the values you entered will not get lost. If you CANCEL instead of SAVE, then there are no pending changes listed. Changes to Alarm page: Ensure if

CANCEL button is pushed, then cancel any possible pending changes. Fixed IDs screen: Fixed some typos, re-sized IDs page a bit smaller, Activated the "Character Count" display for Initial/Pending/CW ID entries. Fixed to not loose user settings when switching between ports. CANCEL will ensure any pending changes are removed. Changes to Messages page, ensure that user entries are not lost when switching the screen between different message (macro) subsets. Ensure that when user presses CANCEL button, all pending changes are erased. Fixed DTMF Memory page. CANCEL button ensures any pending changes are cancelled. When switching between sets of 10 DTMF memories, will not lose user's (previous) choices. Updated the Logic Alarms page. User should no longer loose previous entered entries. Selecting CANCEL will ensure any previous (pending) changes are not saved. For Special Codes page, ensure that when CANCEL is pressed, that any/all pending changes are removed. Port Switches page, ensure all user entered changes are recorded. Ensure all pending changes are erased when the CANCEL button is hit. Fixed problem with Scheduler set points not being saved properly into the data file. Added pop-up window showing parameter save progress to each type of parameter when the SAVE button is pressed. When the main page SAVE button is pressed (save all parameters), a pop-up progress bar shows the user the current saving progress. Fixed Timers dialog so does not loose changes when switching from different radio ports. General Timers-> macro to use, default to NONE. Macros dialog: Fixed so as to not loose changes when switching between (sub-)macros screen. Main dialog page is now slightly narrower. Fixed problems with "Macro" page sometimes setting values as pending, even if they were cancelled. Should now be able to move about the various "sub-screen" pages and not lose any changes.

- RC210_CFG: Fixed problem when using an external eeprom board instead of the RTC board, where it was not updating the CRC value in the external eeprom backup image(s). Added some text on the screen for how to enable TAIL Messages, and RECEIVER Macros. Fixes to problems when doing an UPLOAD ALL, and not seeing some of the "just" uploaded parameters. MUST be used with RC210 firmware v1.1.6C or newer. Fixed problem with Port Restrictions (in Macros page) not working properly.
- RC210 firmware: Fixed problems with reading back Scheduler setpoints, and DTMF memories using DF1/RCP serial protocol, back to RC210_CFG program.
- RC210_CFG: Before performing a parameter Upload/Download, or a Commit operation, read the RC210 firmware version info and compare it against what is expected. If the RC210 firmware version does not match, ABORT the operation.
- RC210_CFG: Fixed problem in internal DF1 driver where if the RC210 firmware did not send a reply message, Df1 driver would send a DEL-ENQ sequence, then the re-sent (original) DF1 request message had not data in it. This cause the DF1 driver to hang, always sending "blank" DF1 messages. Added a timeout when waiting for the DF1 message send to complete. Will now try 3 times to repeat the SEND-RESPONSE message sequence.
- RC210_CFG changes: Fixed Upload ALL and Download ALL, Upload ALL was missing some parameters: Scheduler Set-Points, and DTMF memories. Changes to (DF1) internal communication driver to fix a race condition. (NOTE: there still seems to be a DF1 communication lock-up problem sometimes) Functional change: After performing a successful UPLOAD ALL, the previously grayed-out buttons are made active. This allows a user to perform an UPLOAD ALL, then review the parameters just uploaded. THE DF1_MONITOR command line tool improved in Debug mode to easier see the DLE sequences.
- Added support to DTMF **85dddd**... decode and read-back to also speak the following two DTMF digits:
* - speaks an "S"
- speaks a "P".
- DTMF Memories and DTMF Duration and Delay parameter support added. Added unlocked DTMF command support for ***2105**, ***2106**, and ***2107** DTMF commands. Macro functions: **259-278** and **521-540** now supported. DTMF memories 1-18 are supported by base RC210. If the RC210 has the additional DS2433 memory chips installed, then support is available for DTMF memories **19-40**.
- Macro Command Port restrictions support added. Controlled from (unlocked) DTMF commands ***4005xxxxyy** and ***400699** and from RC210_CFG program.
- Added support for Receive Active/Inactive Macros. Added Macro command support for macro functions: 358-363.
- Changed the firmware power-up spoken message (*says firmware version number*) to use a

	<p>fixed start-up delay of 500 msecs, and then do not use the programmed speech delay parameter while speaking the start-up message. This ensures that the start-up message is not delayed.</p> <ul style="list-style-type: none"> • Scheduler support added. DTMF *4001 command support and Macro functions 810-889 supported. NOTE: NVM some memories have been moved / displaced to make room for the new Scheduler set-point memories and DTMF memories. Scheduler Set points 1-20 are supported by the base RC210. If the RC210 has the additional DS2433 memory chips installed, then support is available for Scheduler Set points 21-40. • Note: RC210 firmware: you must save all previous configuration with RC210_CFG v1.1.5 (previous version), and then clear all NVM, then write all NVM parameters using RC210_CFG v1.1.6 removed the annoying pop-up that occurred after selecting the data file. • COS/PLIN input port signal de-bouncing (noise suppression) is now implemented. This fixes problems when using mechanical relays to drive COS/PLIN inputs. De-Bounce support is added per radio port. If this value is set to zero, then no input port de-bouncing will occur. <i>(will act the same as older firmware versions)</i> Can be set between 0-255. Each value of the de-bounce variable adds 10msec de-bounce input delay. Added new unlocked DTMF command: *2198x to set the input de-bounce counter (per unlocked radio port)
<p>1.1.5</p>	<p>RC210 vA1.1.5 firmware, RTC V1.04 firmware, RC210_CFG program v1.15</p> <ul style="list-style-type: none"> • RC210_CFG: Added support for Macro Pre-Access Range setup. Changed all the dialog box's DISMISS buttons to instead say: CANCEL CHANGES. This makes it clear what the button will do. When clicking on the CANCEL CHANGES button, internally do not save the user's entered changes to fix a previous issue where it would then indicate that there were new changes to be downloaded. • Added support for new feature: DTMF Pre-Access code Range setting. Uses DTMF (when unlocked) command: *4020XXXYYY or *4020XXYY to setup the desired Range of Macros that the DTMF Pre-Access code will be applied to. This allows only a single range of Macros to be used with the DTMF Pre-Access code. Macros not with this range will NOT be used with the DTMF Pre-Access code. In the DTMF command: *4020XXxYYy, XXx is the starting macro range number (00-99, or 000-255) and YYy is the ending (inclusive) macro range number (00-99, or 000-255). • Added drivers for the external 24LC256 eeprom memory chip board. This is an optional PCB that can be used in-place of the RTC option PCB. The external 24LC256 eeprom option board is automatically presence detected if the ARCOM RTC board was not found. Can be used as a backup configuration parameter memory if the RTC board is not to be used. • Fixed problem where the CW "W" character was not being sent out, only a long-transmitted space instead. • Added new DTMF command *21BBCx (only available while unlocked) used to help debugging firmware crash issue. Will read-back any of the four internal task stack low-water marks. (meaning lowest stack level ever seen) "X" = 0 for HLCDVR task, 1 for OSS Startup/worker task, 2 for HLC core task, 3 for FreeRTOS timer task, and 4 is for FreeRTOS Idle task. X set to 5 will read-back the amount of the FreeRTOS (static) heap that has not been assigned. • Fixed a DTMF parsing problem, where sometimes the unlock code would also trigger an un-intended DTMF operation too. • Fixed a problem of firmware crashing on DVR record user function. When a fatal firmware error does occur; for the production version, display the error code number on the LEDs, then reset the controller. The debug version will stay in a loop displaying the fatal error number forever. • Fixed a problem found on DE equipment. When AC-3 module was set to not require CTCSS tone (but RC210 firmware did require a tone); what happened is that when AC-3 was set to not need a CTSSS tone, transmitting into the repeater receive would NOT result in a transmit condition. This was tracked down to the DE repeater activates PLIN first before COS, when AC-3 switch was put in the "down" (disable) position. Normally, when AC-3 switch is set up (require CTCSS tone), the COS signal appears first, then the PLIN signal.

	<ul style="list-style-type: none"> • Correct transmit timeout processing, now will use macro message #39 for spoken message on transmit timeout condition. Will use macro message #40 for spoken message on transmit timeout reset condition. Transmit timeout Reset/CANCEL timer is only started on loss of COS. This means the user that is timing out the repeater, MUST stop transmitting before the TO reset/cancel condition can be cleared.
1.1.4	<p>RC210 vA1.1.4 firmware, RTC V1.04 firmware, RC210_CFG program v1.14</p> <ul style="list-style-type: none"> • Fixed a problem with the Kerchunk timer sometimes causing a lost COS input state which resulted in a hanging radio port transmit and possible loss of linked port audio being transmitted. • Changed the radio port "kerchunk" timer to use a 10msec resolution hardware timer instead of the previous 100msec software timer. Fixed problems with the Kerchunk timer where it would keep counting down (and expire) even if the COS and/or PLIN signal went away. This was causing false Kerchunk timer activations. • Fixed problem where if firmware is restarted, and no COS/PLIN activations occur, then the RC210 did not go into the lower power mode (down to about 50ma) • Fixed problem where if a DTMF command was sent when the Initial ID is also ready to be transmitted, it would result in the Initial ID only partially being sent out. The Transmitter would get turned off too soon. • When disabling the transmitter either by unlocked DTMF command, or by macro function, ensure that the transmitter is actually turned off at the time the command is performed. • Changed the verbal reporting of time to say "oh" instead of zero for minutes less than 10. • Added verbal feedback to ALL correctly user entered DTMF commands while RC210 is unlocked. This ensures the user will get audio feedback to each and every DTMF command issued. (Assuming a valid/true DTMF command was used) • Fixed problem of when unlocking the RC210, and then issuing the "Lock" command, some repeaters would transmit noise until the internal lock command processing was completed. Fixed a problem when issuing the "Lock" command that the Transmit hang-timer would run too fast, resulting in the courtesy tone getting cut off. Reverted back to only processing DTMF keys on EITHER COS closure or CTCSS closure, but not both. This means that the RC210 firmware MUST be setup correctly to DTMF evaluate on COS or CTCSS closure. In most cases set it to evaluate on CTCSS closure. If setup wrong, can get DTMF command spoken result after courtesy tone, or no courtesy tone.
1.1.3	<p>RC210 vA1.1.3 firmware, RTC V1.04 firmware, RC210_CFG program v1.1.3</p> <ul style="list-style-type: none"> • Attempt to fix stuck transmit when a pending CW ID is sent. • Fixed problem where Macro functions: 331, 332, 333, had the side effect of setting zero hang time all the time. • Fixed problem where when sending a voice Pending ID on a port that had ongoing linked port audio being transmitted, it would send the voice pending ID, but then shut off the port's transmit at the end of the voice pending ID. The linked audio would then not be heard, because the port's transmit was shut off. • Fixed problem where when sending Initial ID in voice, and user keys up, it would switch to CW, but there was no courtesy tone sent when the tx is shut

	<p>off.</p> <ul style="list-style-type: none"> • Fixup potential problem on PLIN true state, from previous change of not clearing flags/variables on COS true state (but was not used). All of this should only happen on a DE type repeater. (Or a repeater that has COS go true first, the CTCSS go true later.) • Improved handling COS Activate/Deactivate states. Now, when COS has been determined to not going to be used (no PLIN present), The COS true state will NOT set/clear internal variables/flags, and the COS false state will also not set/clear internal variables/flags. This fixes a problem found on DE repeaters, where if during transmit of Initial ID, if a COS activation occurred (but no PLIN/CTCSS), the tx would get stuck on. (But could be cleared with a normal repeater key-up). • Pending IDs (CW or Voice) were sometimes ending with a courtesy tone - Fixed. Stop doing courtesy tones while port is unlocked. When a radio port was setup requiring COS and CTCSS, COS only activations where causing the transmit to be stopped during voice IDs, and stopping initial IDs from playing. • RC210_CFG: v1.13 - Updated version number only.
1.1.2	<p>RC210 vA1.1.2 firmware, RTC V1.04 firmware, RC210_CFG program v1.1.2</p> <p style="text-align: center;">*** <u>Support Added for RC210 PCB Rev 4.0</u> ***</p> <ul style="list-style-type: none"> • There are now 2 different firmware binaries built for each type of RC210 PCB hardware: V3.5 and v4.0 (RC210 4.0 PCB uses the 2560 MCU, while the RC210 v3.5x PCB uses the 2561 MCU). The file: RC210V35_FW_Av1.1.2.Bin is for the RC210 board v3.5x, and the file: RC210V40_FW_Av1.1.2.Bin is for the RC210 board v4.0. • Added new DTMF command: <i>*21BBB</i>. This command (when firmware is unlocked) will report/speak the type of RC210 firmware build. For Debug firmware builds this will be “D2560” for rev 4.0 RC210 PCB or “D2561” for rev 3.5x RC210 PCB. For Release firmware builds this will be “R2560” for rev 4.0 RC210 PCB or “R2561” for rev 3.5x RC210 PCB.
1.1.1	<p>RC210 vA1.1.1 firmware, RTC V1.04 firmware, RC210_CFG program v1.1.1</p> <ul style="list-style-type: none"> • Fixed a problem where if two ports where linked, and one of them was a simplex radio, AND the port configuration for the simplex radio did NOT have the DTMF option enabled, then when un-keying on the simplex radio, the other linked port (a repeater in this test case) would get it’s transmit left on. Fixed.
1.1.0	<p>RC210 vA1.1.0 firmware, RTC V1.04 firmware, RC210_CFG program v1.1.0</p> <ul style="list-style-type: none"> • The Kerchunk Timers now work as expected. They will affect both the radio port they are associated with, and any currently linked ports. • The Transmit Hang Timers now runs concurrently with any selected courtesy tone. If your courtesy tone is “cut short”, increase the transmit hang timer value. • Added DTMF command <i>*21BBA</i>. This command (when controller is unlocked) will report the DS18B20 Digital Temperature Sensor initialization findings: 1st number spoken is the number of devices found; the 2nd number spoken is the # of bits resolution.

	<ul style="list-style-type: none">• When performing a user DVR record session, allow the incoming audio (user's voice) to be transmitted out the repeater. (this only applies if the port is setup as a repeater)
--	---

2. ALTERNATE FIRMWARE INSTALLATION

2.1 Non-Volatile Parameters Full Erase by Version Requirements

The following table shows when upgrading from specific firmware versions WHEN the complete erase of all NVM parameters is required.

Upgrade to Version	From Version(s)	Full EEPROM Erase required:
1.1.20	1.1.19	No (versions <= 1.1.6 = Yes)
1.1.19	1.1.18	No (versions <= 1.1.6 = Yes)
1.1.18	1.1.17	No (versions <= 1.1.6 = Yes)
1.1.17	1.1.16	No (versions <= 1.1.6 = Yes)
1.1.16	1.1.15	No (versions <= 1.1.6 = Yes)
1.1.15	1.1.14	No (versions <= 1.1.6 = Yes)
1.1.14	1.1.13	No (versions <= 1.1.6 = Yes)
1.1.13	1.1.12	No (versions <= 1.1.6 = Yes)
1.1.12	1.1.11	No (versions <= 1.1.6 = Yes)
1.1.11	1.1.10	No (versions <= 1.1.6 = Yes)
1.1.10	1.1.9	No (versions <= 1.1.6 = Yes)
1.1.9	1.1.8	No (versions <= 1.1.6 = Yes)
1.1.8	1.1.7	No (versions <= 1.1.6 = Yes)
1.1.7	1.1.6	No (versions <= 1.1.6 = Yes)
1.1.6	All previous versions	Yes
1.1.5	1.08-1.1.4	No
1.1.4	1.08-1.1.3	No
1.1.3	1.08-1.1.2	No
1.1.2	1.08-1.1.1	No
1.1.1	1.0.8-1.1.0	No
1.1.0	1.0.8-1.0.21	No
	1.0.7 and older	Yes
	Any ARCOM firmware	Yes

2.2 Save current RC210 Configuration

Use the RCP windows software, to save you current configuration into a (new) data file by using RCP's **Download** button. Ensure your serial cable COM port number is set correctly first.

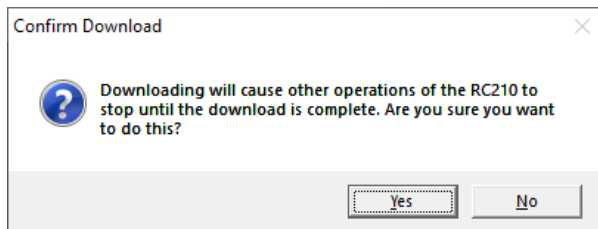

Press Yes

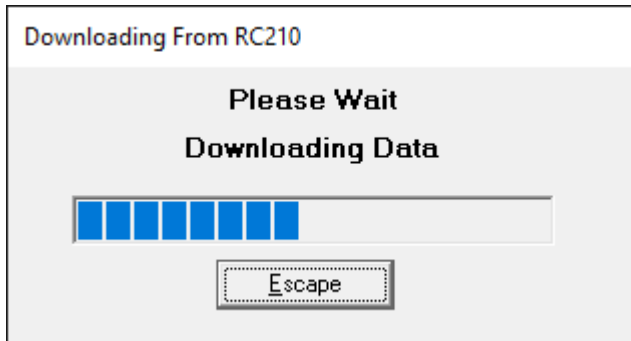

Wait for download to complete.

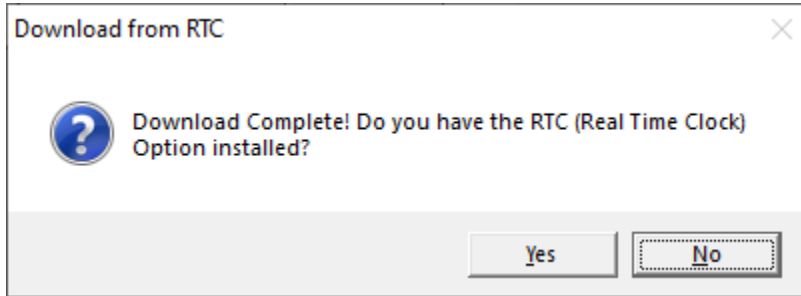

Answer Yes or No depending if you have the RTC board installed.

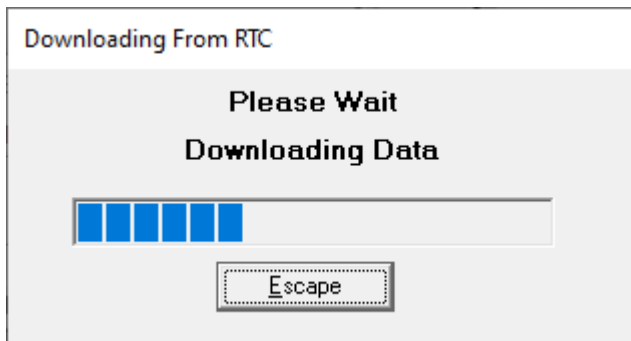

Answer Yes or No depending if you have the AutoPatch board installed.

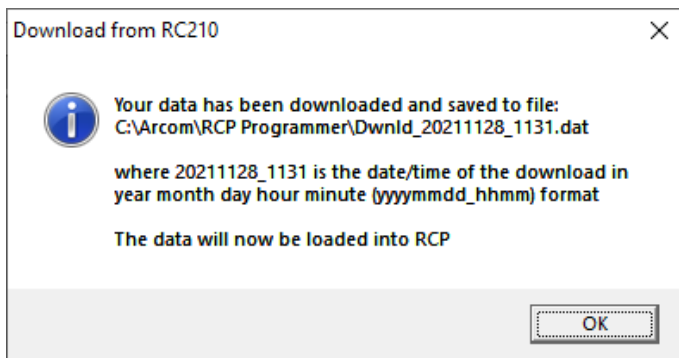

Press OK

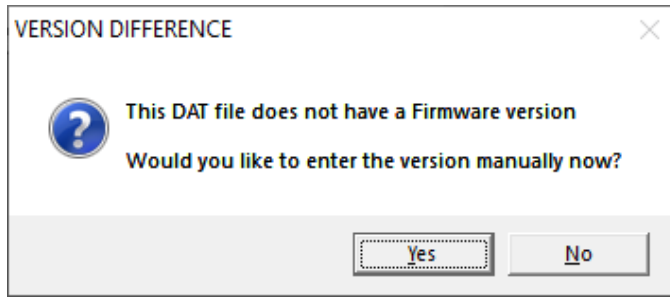

Press Yes

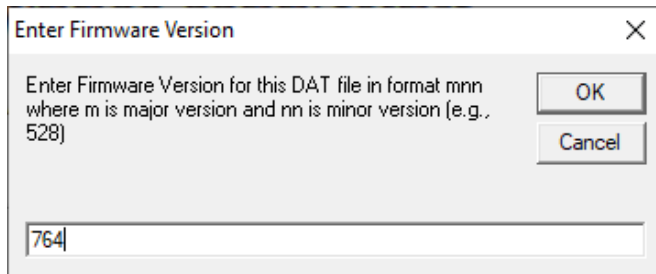

Enter your version number, Press OK

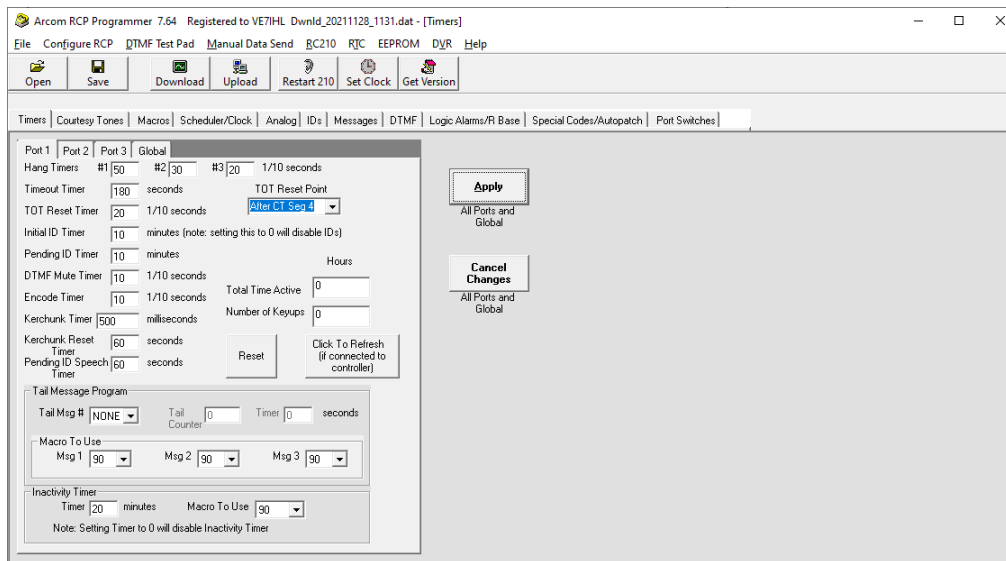

Use the File->Sav As menu option to save a copy of your DAT file to your preffered location. Close RCP.

2.3 Install Alternate Firmware to the RC210

To install the alternate RC210 firmware, first use the windows installer package executable: **RC210_AFW_v1.1.20_Setup.exe**. This will install the RC210 and RTC firmware update files and the RC210 Configuration Program to your Windows hard drive. Typical installation path is C:\RC210_AFW\AVX.x.x.

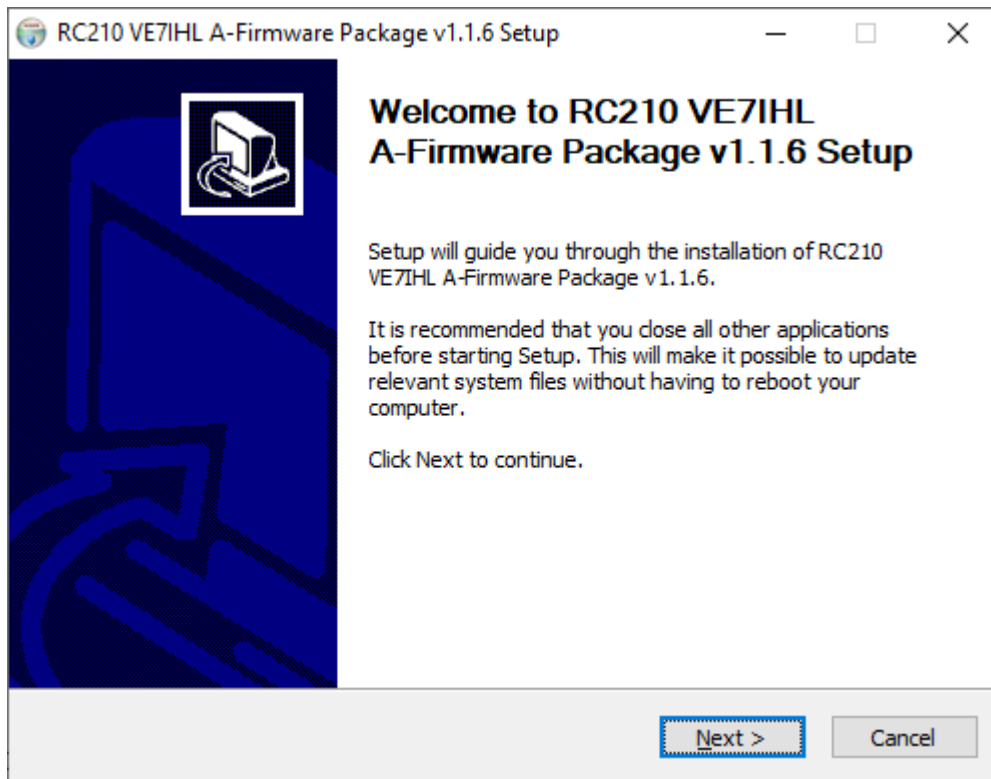

Press NEXT

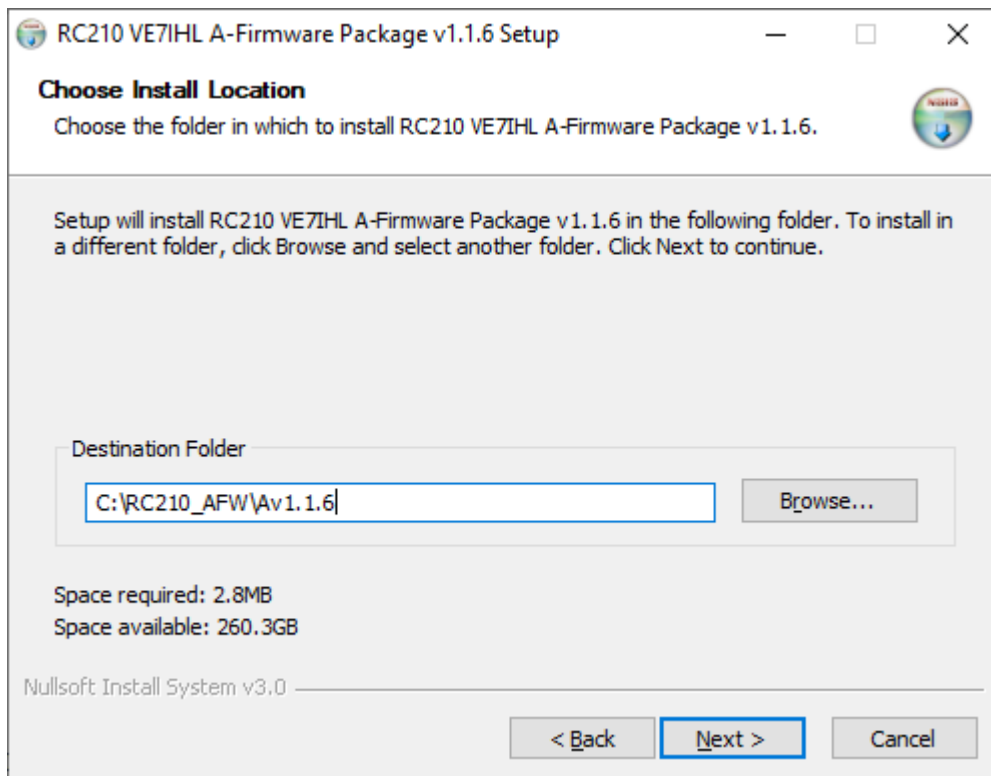

Select install path, press NEXT

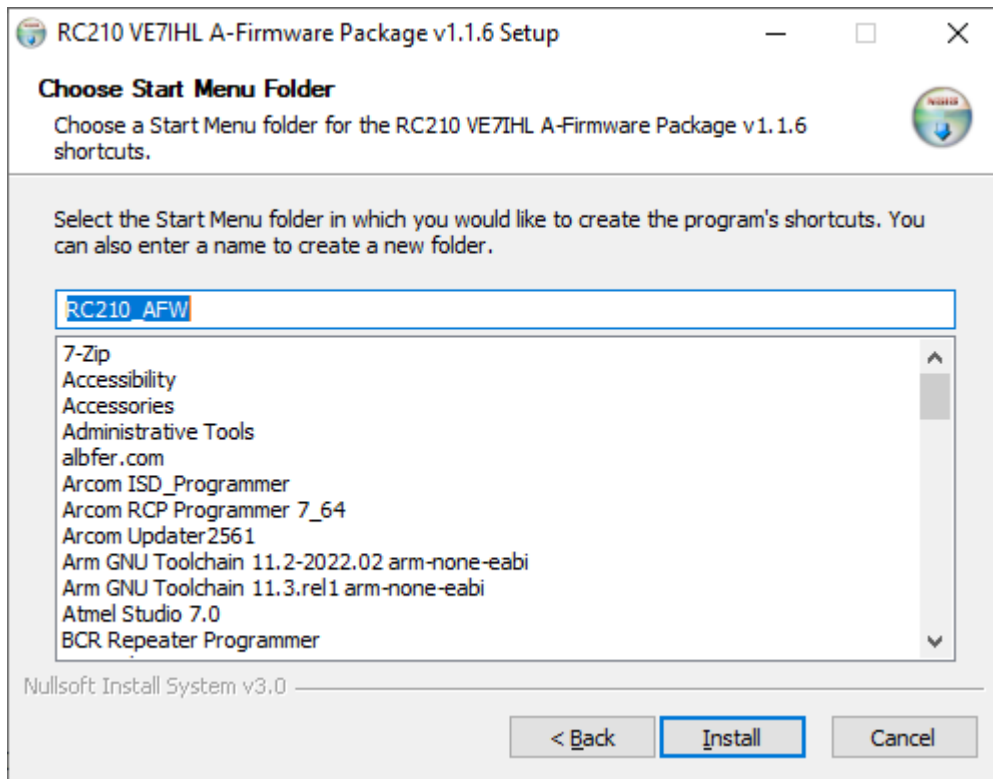

Press INSTALL

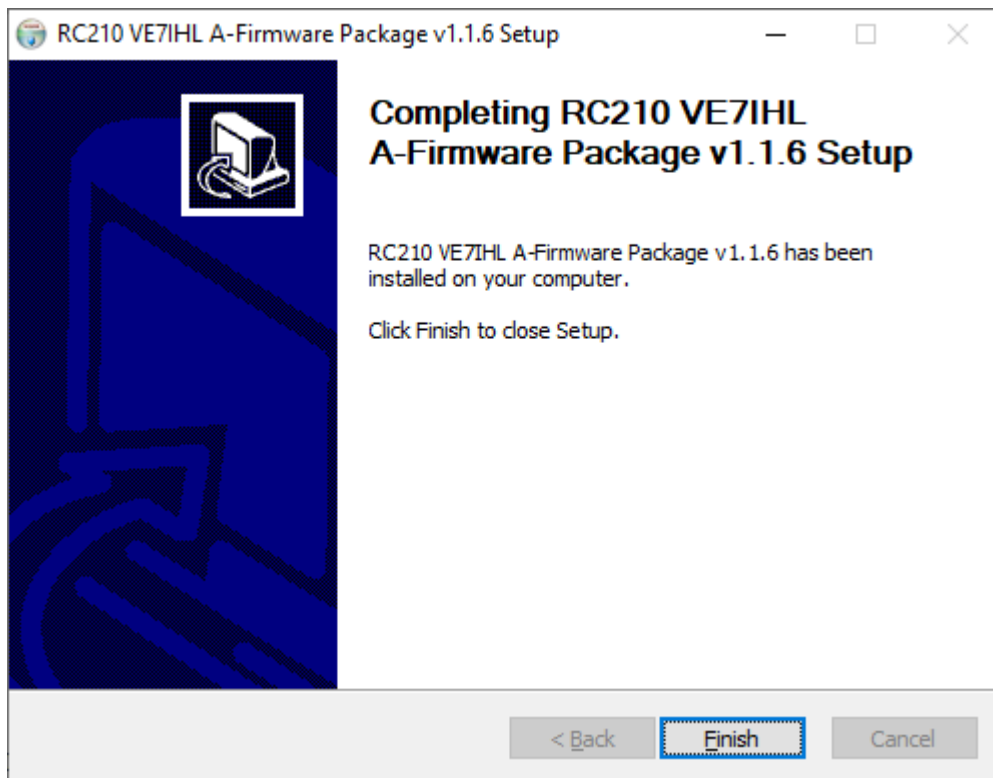

Press Finish

Then use the **RC210V35 FW Av1.1.20.bin** file (for RC210 hardware revision 3.5x/4.1 PCBs) or the **RC210V40 FW Av1.1.20.bin** (for RC210 hardware revision 4.0 PCBs) file; and upload to the RC210 board using the ARCOM 2561 Updater tool. Ensure your (USB) Serial port cable is connected to the RC210 serial programming port and verify the correct COM port number in use by your (USB) serial cable. In the example screen image below, it shows in the Windows 10 Device Manager under “Ports”, that the serial cable in this case is on COM1:

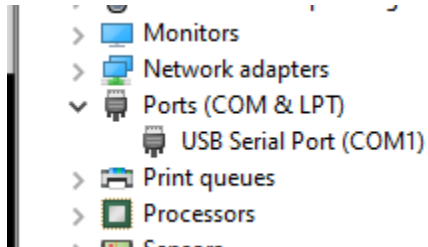

When using the ARCOM 2561 Updater tool, make sure the COM port selection matches the COM port number your serial cable is: (COM1 is shown this case)

*NOTE: the following screen images may indicate a different alternate firmware version file. Substitute the **RC210Vxx_FW_Av1.1.20.Bin** file in its place.*

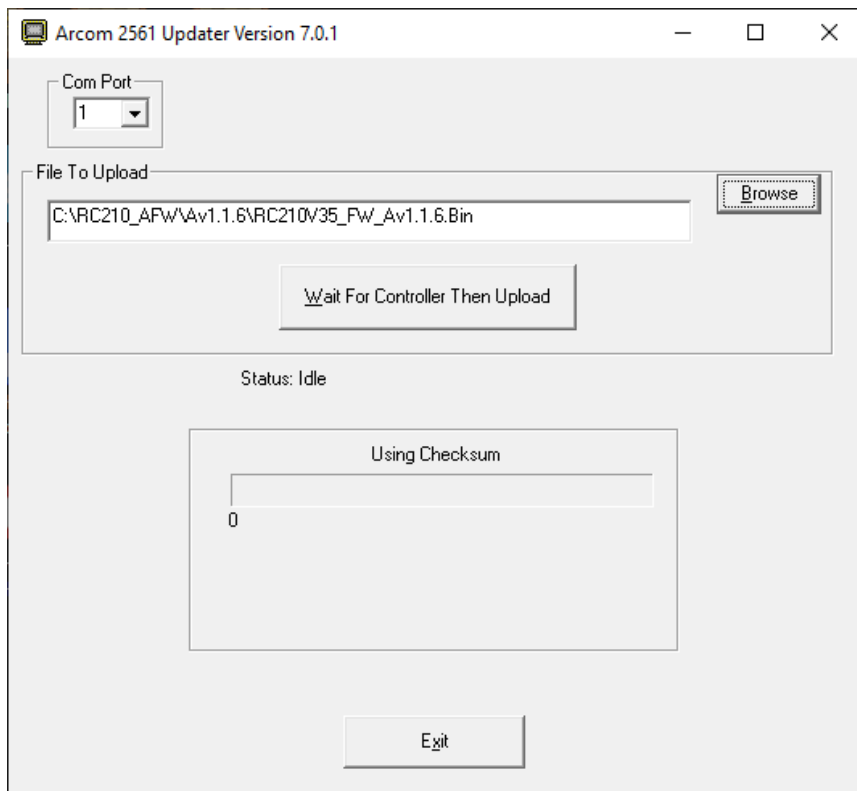

Use the **Browse** button to locate the alternate RC210 firmware .bin file:

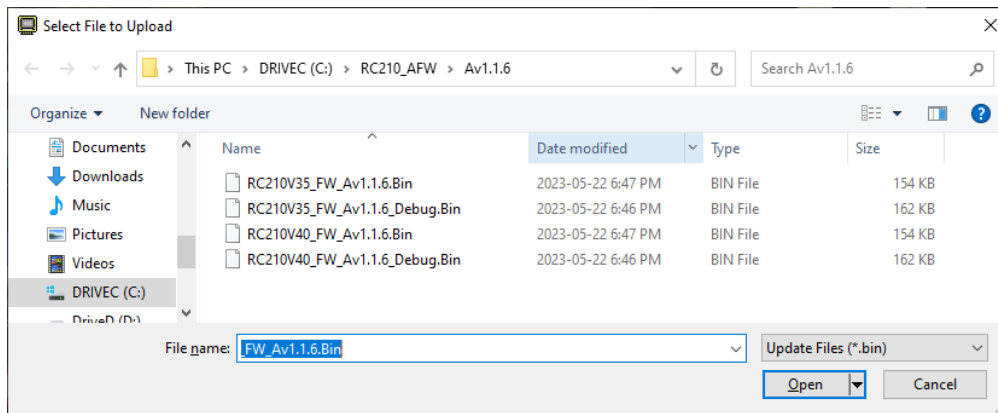

Click Open. Then click the **Wait For Controller Then Upload** button, and ensure the upload proceeds without errors.

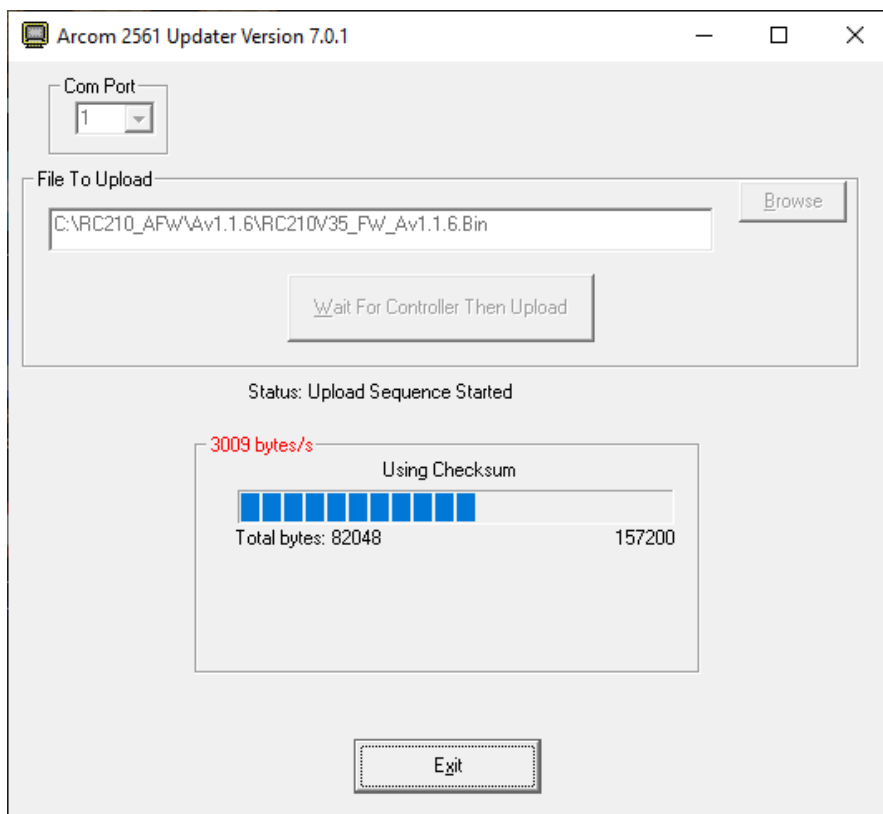

Once the alternate RC210 firmware has completed loading you should get the following message.

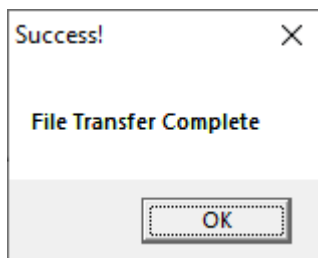

Press OK, then Press Exit.

The RC210 COS and CTCSS front panel LEDs may be alternately flashing. This means that the non-volatile parameters were found to be invalid. This can be ignored for now, and will be fixed in the first RC210 configuration step.

It will startup and announce its startup message and version number on radio port #1. Note that at this time, all the configuration parameters will be set to factory defaults and it will announce “*NVM Error*” at the end of its startup voice message.

You will now use the new Windows **RC210 Configuration Tool** to complete the initial setup of your RC210 configuration.

2.4 Initial RC210 Configuration

The next steps will use the new RC210 Configuration tool to accomplish the initial configuration.

1. Erase and Initialize all Configuration parameters (updates internal parameter CRC error checking).
2. Reset RC210.
3. Upload all the parameters from the RC210.
4. Save the uploaded parameters into a new data file

Note: The new **RC210 Configuration Tool** uses a data file format that is *different* from what the ARCOM RCP tool uses. You can NOT use the two different data files interchangeably. Open the RC210 Configuration tool by double-clicking on the **RC210_CFG_Av1.1.20.Exe** file, or use the desktop ICON placed there by the windows installer. You should see the following opening screen:

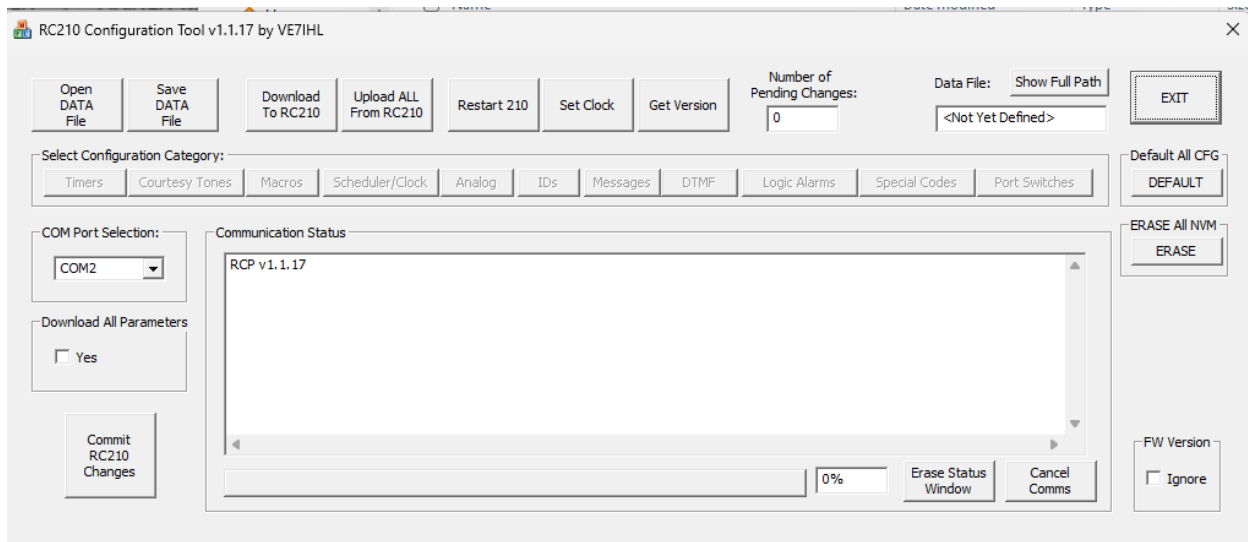

To confirm that serial communications are setup correctly between the RC210 Configuration tool and the RC210 serial port, press the **Get Version** button. It should return the current alternate RC210 firmware version number:

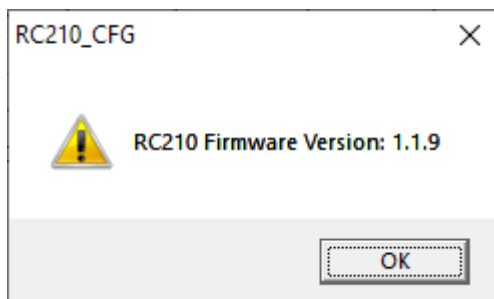

2.4.1 Erase all NVM Storage Areas

Press the **ERASE** button to initiate a complete erase of all RC210 eeprom storage spaces.

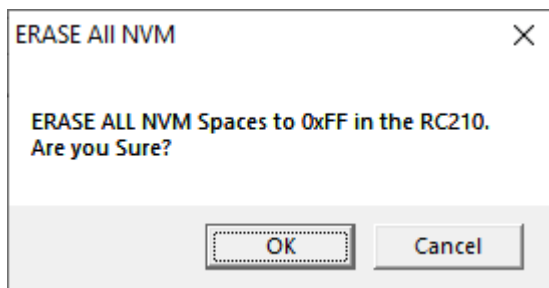
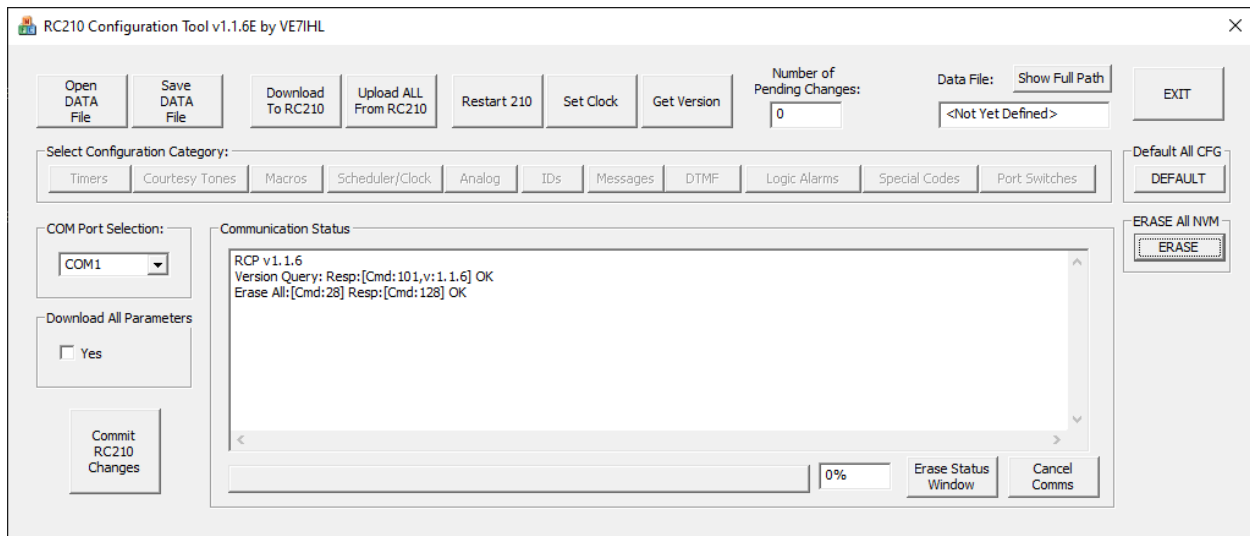

Press OK

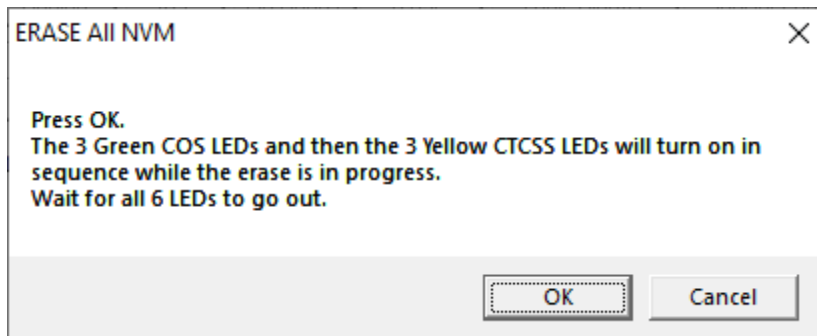

Press OK. Wait for all 6 LEDs to go out. Proceed to the next section to write in factory default configuration parameters.

2.4.2 Initialize all Parameters

Press the **DEFAULT** button to start a complete non-volatile parameter write to factory defaults:

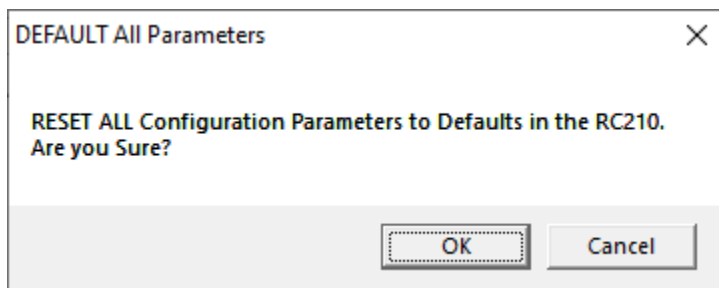
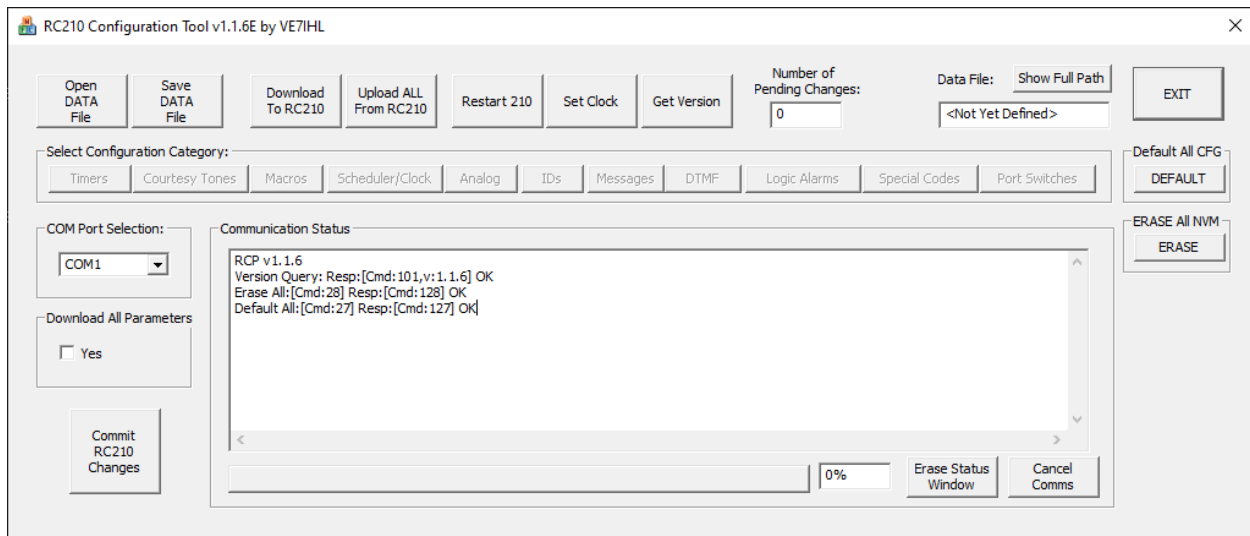

Press OK.

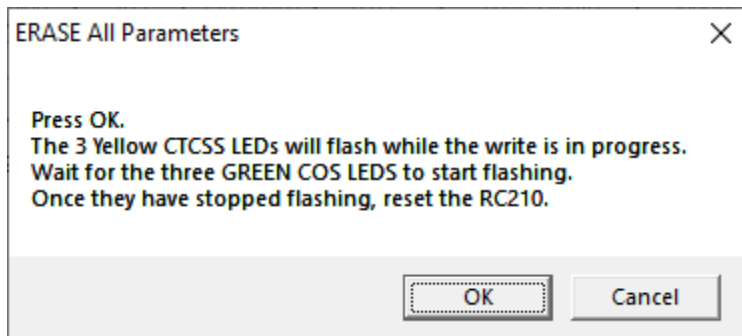

Press OK. Wait for the three green COS LEDS to start flashing and the stop flashing. Proceed to the next section to reset the RC210 firmware.

2.4.3 Reset RC210

Reset the RC210 using the **Restart RC210** button. Wait for the RC210 to complete its restart and send out the voice startup message out radio port #1. (This assumes you have a working radio connected to port 1)

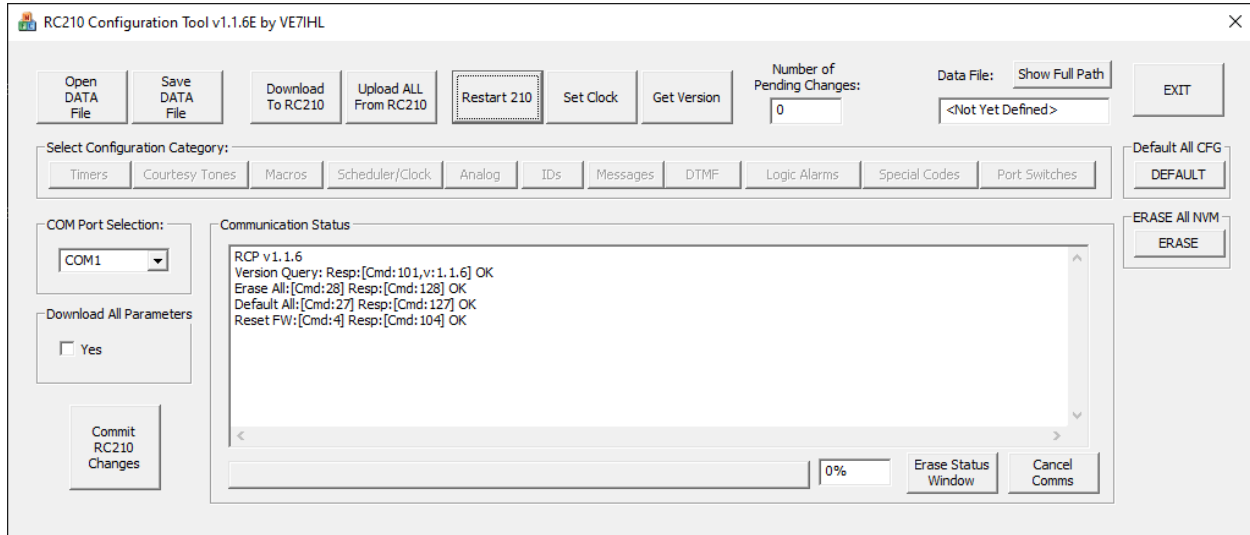

2.4.4 Read in all RC210 Parameters

Read in all the factory default RC210 configuration parameters by selecting the **Upload ALL From RC210** button.

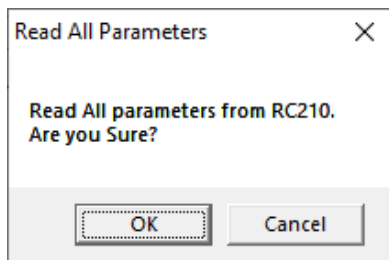

Press **OK**. There will be a lot of communication status messages scrolling by in the *Communication Status* window. You can ignore them for now. This is debugging information for the software developer.

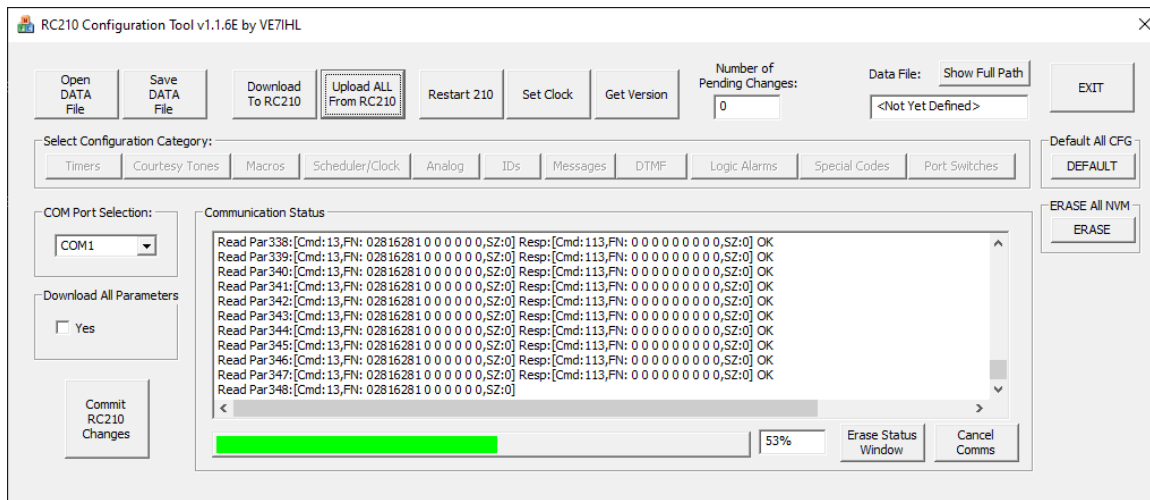

Wait for all the configuration parameters to be read from the RC210 board, (Progress box will go to 100%).

2.4.5 Save all Parameters to DATA File

Once all the configuration parameters have been read from the RC210 board, press the **Save DATA File** button to save/update your new RC210 data file:

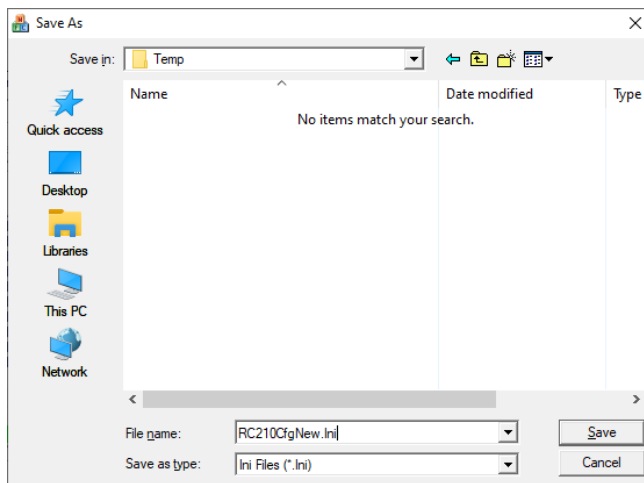

Enter the desired RC210 data filename. Press the **Save** button.

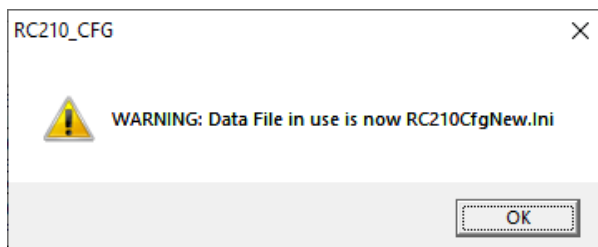

You can ignore the above warning message.

You can now proceed to the next section to start your RC210 configuration.

2.5 Using the RC210 Configuration Tool

When using the new RC210 Configuration tool, it works differently than the ARCOM RCP tool. You must first open a data file before any configuration can begin. Press the **Open DATA File** button and select the name of the file you wish to hold the RC210 configuration data in.

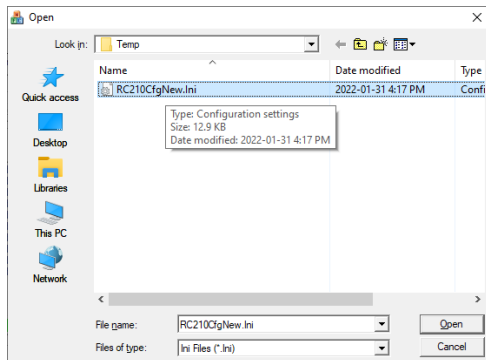

This example shows filename RC210CfgNew. Press **Open**

If you get this message, press **Yes** to create the new file.

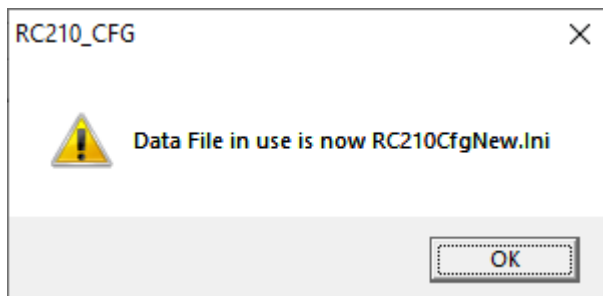
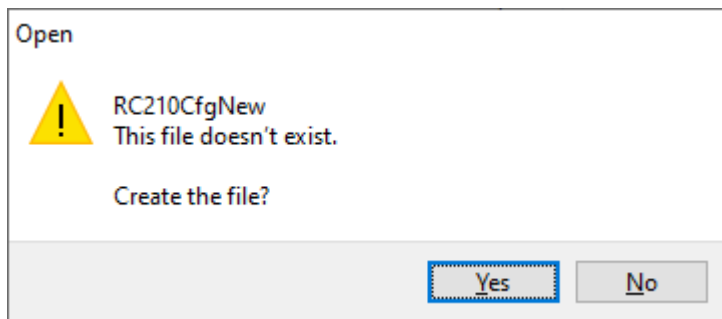

Press OK

You may now proceed to change/update the RC210 configuration parameters. The RC210 configuration tool works similar to the ARCOM RCP tool, but not all features are present. Also, after making parameter changes and downloading them to the RC210 (Use the **Download To RC210** button), a final step of pressing the **Commit RC210 Changes** MUST be done to have the new/changed parameters saved into the internal RC210 non-volatile memory. See the circled button on the screen image below. NOTE: to download ALL parameters to the RC210, enable the check-mark box entitled *Download All Parameters*.

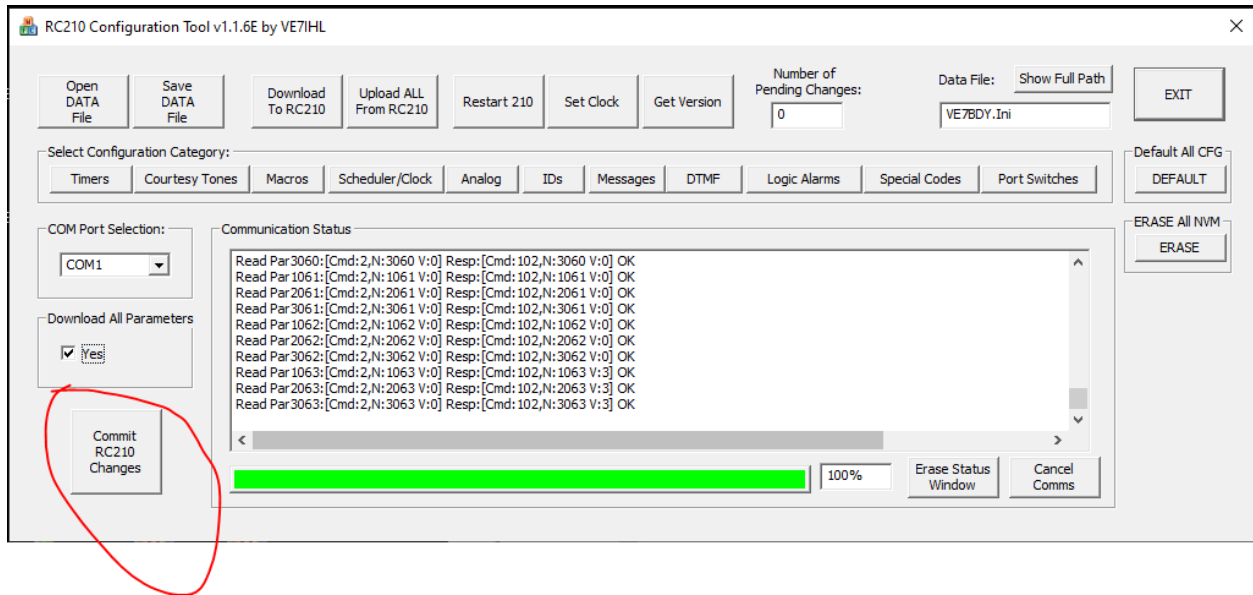

Always use the **Save DATA File** button after making any changes. When restarting the RC210 configuration tool, use the **Open DATA File** button to read in your previously saved configuration data.

Some example configuration screens are shown below:

RC210 Timers Configuration
✕

Radio Port Selection

Port 1 Port 2 Port 3

Save Changes

Cancel Changes

Port Specific Timers

Hang Timers: #1 #2 #3 1/10 seconds

Timeout Timer: Seconds TOT Reset Point

TOT Reset Timer: 1/10 seconds After CT Seg 4

Initial ID Timer: Minutes (setting to zero will disable IDs)

Pending ID Timer: Minutes

DTMF Mute Timer: 1/10 seconds

Encode Timer: 1/10 seconds

Kerchunk Timer: milliseconds

Kerchunk Reset Timer: Seconds

Pending ID Speech Timer: Seconds

Input DeBounce Timer: 1/100 seconds (10 msec counts)

Tail Message Program

Tail Msg # Tail Counter Timer Seconds

Macro To Use:

Msg 1 Msg 2 Msg 3

Inactivity Timer

Timer: Minutes Macro To Use:

NOTE: Setting Timer to zero will disable inactivity timer

Global

FAN

Minutes

All Xmt Activity

Speech/CW Delay Before Transmit

msec

Timeout Timer Control

Enable Linking Control

General Timers Macro To Use

Timer 1:	<input type="text" value="120"/> Seconds	<input type="text" value="34"/> <input type="text"/>	<input type="text" value="34"/>
Timer 2:	<input type="text" value="65"/> Seconds	<input type="text" value="36"/> <input type="text"/>	<input type="text" value="36"/>
Timer 3:	<input type="text" value="0"/> Seconds	<input type="text" value="NONE"/> <input type="text"/>	<input type="text" value="NONE"/>
Timer 4:	<input type="text" value="0"/> Seconds	<input type="text" value="NONE"/> <input type="text"/>	<input type="text" value="NONE"/>
Timer 5:	<input type="text" value="0"/> Seconds	<input type="text" value="NONE"/> <input type="text"/>	<input type="text" value="NONE"/>
Timer 6:	<input type="text" value="0"/> Seconds	<input type="text" value="NONE"/> <input type="text"/>	<input type="text" value="NONE"/>

REMINDER: Tail Messages MUST be enabled via a macro function to work!
 (Look at Macro Fns: 309-320)

Courtesy Tone Pool
✕

Courtesy Tone Select

NOTE: Setting Segment 1, Tone 1 to less than 41 will cause RC210 to use Message macro 1 - 40 for Courtesy Tone

Save Changes

Cancel Changes

Segment 1

Delay To This Segment: ms

Duration: ms

Tone1: Hz

Tone2: Hz

Segment 2

Delay To This Segment: ms

Duration: ms

Tone1: Hz

Tone2: Hz

Segment 3

Delay To This Segment: ms

Duration: ms

Tone1: Hz

Tone2: Hz

Segment 4

Delay To This Segment: ms

Duration: ms

Tone1: Hz

Tone2: Hz

MACROS

MACRO SubSet: 1-10 11-20 21-30 31-40 41-50 51-60 61-70 71-80 81-90

Erase All Macros Save Changes Cancel Changes

Macro	Functions	DTMF Code	Number:	Function:
1	921	NONE	1	Port 1 CTCSS Access
2	251 119 187	760#	2	Port 2 CTCSS Access
3	251 123 188	761#	3	Port 3 CTCSS Access
4	251 118 189	762#	4	Port 1 Carrier Access
5	251 122 190	763#	5	Port 2 Carrier Access
6	251 120 192	764#	6	Port 3 Carrier Access
7	251 124 204	765#	7	Port 1 DTMF Covertone ON
8	251 121 202	766#	8	Port 2 DTMF Covertone ON
9	251 125 203	767#	9	Port 3 DTMF Covertone ON
10	NONE STORED	NONE	10	Port 1 DTMF Covertone OFF
			11	Port 2 DTMF Covertone OFF
			12	Port 3 DTMF Covertone OFF
			13	Port 1 TX Enable
			14	Port 2 TX Enable
			15	Port 3 TX Enable
			16	Port 1 TX Disable
			17	Port 2 TX Disable
			18	Port 3 TX Disable
			19	Monitor Port 1 from Port 2
			20	Monitor Port 1 from Port 3
			21	Disconnect Port 1 from Port 2
			22	Disconnect Port 1 from Port 3
			23	Monitor Port 2 from Port 1
			24	Monitor Port 2 from Port 3
			25	Disconnect Port 2 from Port 1

ONLY decimal values can be entered !!!

Receiver Macros
 NOTE: To use Receiver Macros, you MUST enable via Macro command. (See Macro FN:s 358-363)
 Port: 1
 Macro Active: Disabled
 Macro InActive: 35

Macro Port Assignments
 Macro Number: 1
 Ports Allowed: All Ports
 To Run From:

Function List

Scheduler + Real Time Clock

Scheduler

Set Point Number: 1 Enable

Day of the Week: Everyday

Month to Run: EveryMonth

Monthly

Number of Occurance this Month: 1st

Start Hours: 12 PM

Start Minutes: 00

Macro to Run: 26

Real Time Clock

Set Clock

NOTE: Setting the clock will immediately set the RTC210 clock and calender to your computer's system time

Say Year

24 Hour Readback Say Hours

Clock Correction Seconds

Save Changes Cancel Changes

Analog Inputs

Analog Channel: Ch1 Ch2 Ch3 Ch4 Ch5 Ch6 Ch7 Ch8

Analog Channel

Meter Type: DS18B20

Actual Low Value: Not Used

Meter Low Value: Not Used

Actual High Value: Not Used

Meter High Value: Not Used

Set LM335 Defaults

Digital Channel

Temperature Sensor Resolution: 9 Bits 10 Bits 11 Bits 12 Bits

Temperature Sensor I/O Pins: Output Pin: 2 Input Pin: 1

Reference / Meter Alarms

Meter Alarms

Alarm Number: 1 Meter Number: 1

Alarm Type: Disabled Trip Value: 0

Macro To Call: 90

Reference Voltage: 498

Save Changes Cancel Changes

IDs
✕

Radio Port Selection

Radio Port IDs

Port 1
 Port 2
 Port 3

NOTE: Enabling Constant ID means that an ID will be sent every Pending ID timer interval regardless of the actual repeater activity

Character Counter

 Words (max 22)

NOTE: ID Extra Specials indicate NVM Parameter Status and are always added to the END of a voice ID.

Save Changes Cancel Changes

ZERO
 1
2
3
4
5
6
7
8
9
10
11
12
13
14
15
16

Vocabulary List

ID Extra Specials Definitions

[1] Say if NVM Parameters were Restored or Recovered

[2] Say NVM Parameters Status

Initial ID 1: SILENCE(PAUSE) VE 7 R CT REPEATER

Initial ID 2: SILENCE(PAUSE) VE 7 R CT REPEATER

Initial ID 3: SILENCE(PAUSE) VE 7 R CT REPEATER

Pending ID 1: SILENCE(PAUSE) VE 7 R CT

Pending ID 2: SILENCE(PAUSE) VE 7 R CT

Pending ID 3: SILENCE(PAUSE) VE 7 R CT

CW ID 1: VE 7 R CT

CW ID 2: VE 7 R CT

CW Speed: 20 WPM CW Tone 1: 600 Hz CW Tone 2: 0 Hz

Speech IDs

Enabled

Constant ID

Enabled

ID Extras

Voice ID 1: Cancel ID Extras

Voice ID 2: Cancel ID Extras

Voice ID 3: Cancel ID Extras

ID Extra Specials

1 2

1 2

1 2

Message Macros
✕

Message MACRO SubSet Select

01-10
 11-20
 21-30
 31-40
 41-50
 51-60
 61-70

Erase All Macros Save Changes Cancel Changes

Msg Macro	Functions
1	S I R G LINK CONNECTED 2 6 4
2	S I R G LINK DISCONNECTED FROM 6 4
3	6 4 CONNECTED 2 U H F LINK
4	6 4 DISCONNECTED FROM U H F LINK
5	ALL LINK -S(makes_plural) DISCONNECTED
6	LINK CONNECTED 2 S I R G LINK
7	THE(short) TEMPERATURE IS
8	THE(short) OUT TEMPERATURE IS
9	BATTERY 1 VOLTAGE IS
10	BATTERY 2 VOLTAGE IS

Number:

0 ZERO
 1 1
2 2
3 3
4 4
5 5
6 6
7 7
8 8
9 9
10 10
11 11
12 12
13 13
14 14
15 15
16 16
17 17
18 18
19 19
20 20
21 30
22 40
23 50
24 60

Vocabulary List

DTMF Memories

DTMF Memory SubSet Select

01-10 11-20 21-30 31-40

DTMF Mem	DTMF Codes
1	NONE STORED
2	NONE STORED
3	NONE STORED
4	NONE STORED
5	NONE STORED
6	NONE STORED
7	NONE STORED
8	NONE STORED
9	NONE STORED
10	NONE STORED

Digits:

0
1
2
3
4
5
6
7
8
9
A
B
C
D
*
#

Save Changes

Cancel Changes

DTMF Parameters
These are limited to 0-255 msecs

Duration: 50 mSec

Delay: 50 mSec

Logic (Input) Alarms

Logic Alarm Setup

Alarm Number: Alarm Enabled

High-to-Low Macro To Use: 1 90

Low-to-High Macro To Use: 90

Save Changes

Cancel Changes

Special Codes

Unlock, Lock, Terminator

Port 1 Unlock: 1 to 8 characters

Port 2 Unlock: 1 to 8 characters

Port 3 Unlock: 1 to 8 characters

Global Lock: 1 to 4 characters

Terminator: single character

Voice Command Responses

Enabled

DTMF Pad Test

Prefix: 1 to 5 characters

DR 1X Mode Select

DR 1X Mode Enabled

DTMF Mute Select

1st Digit

2nd Digit

Trigger IDs on Linked ports

Trigger IDs on Linked Ports

DTMF Pre-Access Code

DTMF Pre-Access Macro Range

Start Macro Num:

Stop Macro Num: (Inclusive)

Radio Port Switches

Port 1

Transmitter Enable

Receiver Enable

Repeater Mode

Speech Override

Speech ID Override

Carrier: Access Mode

DTMF Enable

DTMF Require Tone

DTMF Mute

DTMF Covertone

Monitor Mix

Kerchunk Filter

Tone Encode Control

ON During ID/Speech

Timer Starts after COS

Timer Starts after CT

ID Timer Start

On COS On PTT

RSSI Threshold

Low:

High:

Port 2

Transmitter Enable

Receiver Enable

Repeater Mode

Speech Override

Speech ID Override

Carrier: Access Mode

DTMF Enable

DTMF Require Tone

DTMF Mute

DTMF Covertone

Monitor Mix

Kerchunk Filter

Tone Encode Control

ON During ID/Speech

Timer Starts after COS

Timer Starts after CT

ID Timer Start

On COS On PTT

RSSI Threshold

Low:

High:

Port 3

Transmitter Enable

Receiver Enable

Repeater Mode

Speech Override

Speech ID Override

Carrier: Access Mode

DTMF Enable

DTMF Require Tone

DTMF Mute

DTMF Covertone

Monitor Mix

Kerchunk Filter

Tone Encode Control

ON During ID/Speech

Timer Starts after COS

Timer Starts after CT

ID Timer Start

On COS On PTT

RSSI Threshold

Low:

High:

DTMF Evaluate on Closure

Port 1: COS Tone

Port 2: COS Tone

Port 3: COS Tone

Tone Encode Polarity

Port 1: Hi Lo

Port 2: Hi Lo

Port 3: Hi Lo

Allow Speech w/Terminator

TX Timer Units

Minutes

Hours

Use the **DEFAULT** button to write all configuration parameters and return to factory defaults. Press the **Commit RC210 Changes** button to complete the internal write operation.

If you wish to download ALL parameters (*in doing so you will overwrite all existing parameters!*), use the **Download All Parameters** check box. Then use the **Download To RC210** button.

Use the **Restart RC210** button to force the RC210 firmware to restart (same as a power on).

Use the **Set Clock** button to set the Time and Date in the RC210 firmware.

2.6 Prepare DVR Memory Space

If you plan to be using any DVR messages, you will need to initialize the DVR memory space by performing a DVR Memory Erase operation. This will prepare the DVR memory space to hold your voice recordings. Follow the following steps:

1. Using a DTMF capable radio, Unlock access to the RC210 firmware by entering the correct unlock code. (See section on unlock code programming) Default code is 15281 for radio port #1.
2. Wait for the voice prompt indicated port is unlocked
3. Enter DTMF: ***7003** to erase all DVR memory space. (See section on DVR)
4. Wait for voice prompt indicating successful completion
5. Enter DTMF: ***21999** to reset the RC210 firmware.
6. Wait for RC210 to complete the firmware reset
7. Test DVR recording assuming you have a DTMF controller macro setup that uses Macro function **345**.

2.7 RTC Board Firmware Update

NOTE: Starting with RC210 firmware v1.04 - v1.1.11, the RTC firmware also needs to be updated. Also, the RTC board's ATMEGA328P MCU device's internal *Fuses* need to be rewritten. Contact VE7IHL for more information on how to do this.

To use the ARCOM RTC board option with the new alternate RC210 firmware, new firmware needs be installed to this board. If you are just evaluating/testing the Alternate RC210 firmware, the RTC board firmware can be left as is. If you do have the RTC board installed, but with the default ARCOM RTC firmware, the alternate RC210 firmware will work fine, it will just not detect the RTC board. (It will act as if it is not installed)

If you wish to re-flash the RTC board and you have used AVR programming tools before, you will need one of the following AVR programming tools: (*There are other tools too*)

- USBASP – low-cost programmer, available on amazon for as low as \$4.69



- AVRISP MK2 programmer, available on amazon.com



- Atmel ICE debugger/programmer (may require a custom wired adapter)



For programming software for the USBASP you will first need the correct driver loaded from the Zadig tool. Ensure you load the **libusb0** driver:

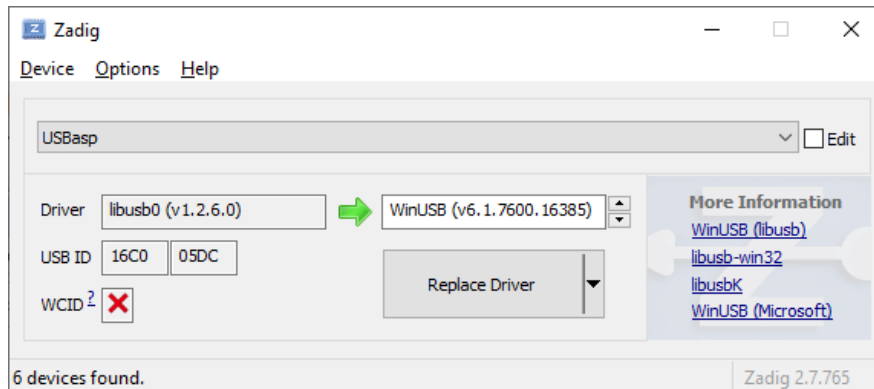

Zadig driver install tool can be found here: <https://zadig.akeo.ie/>

Then use the **eXtreme Burner AVR** programming tool to re-flash the RTC board: Use the hex file supplied: RTC_FW_Av1.0.4.Hex in the instalation folder.

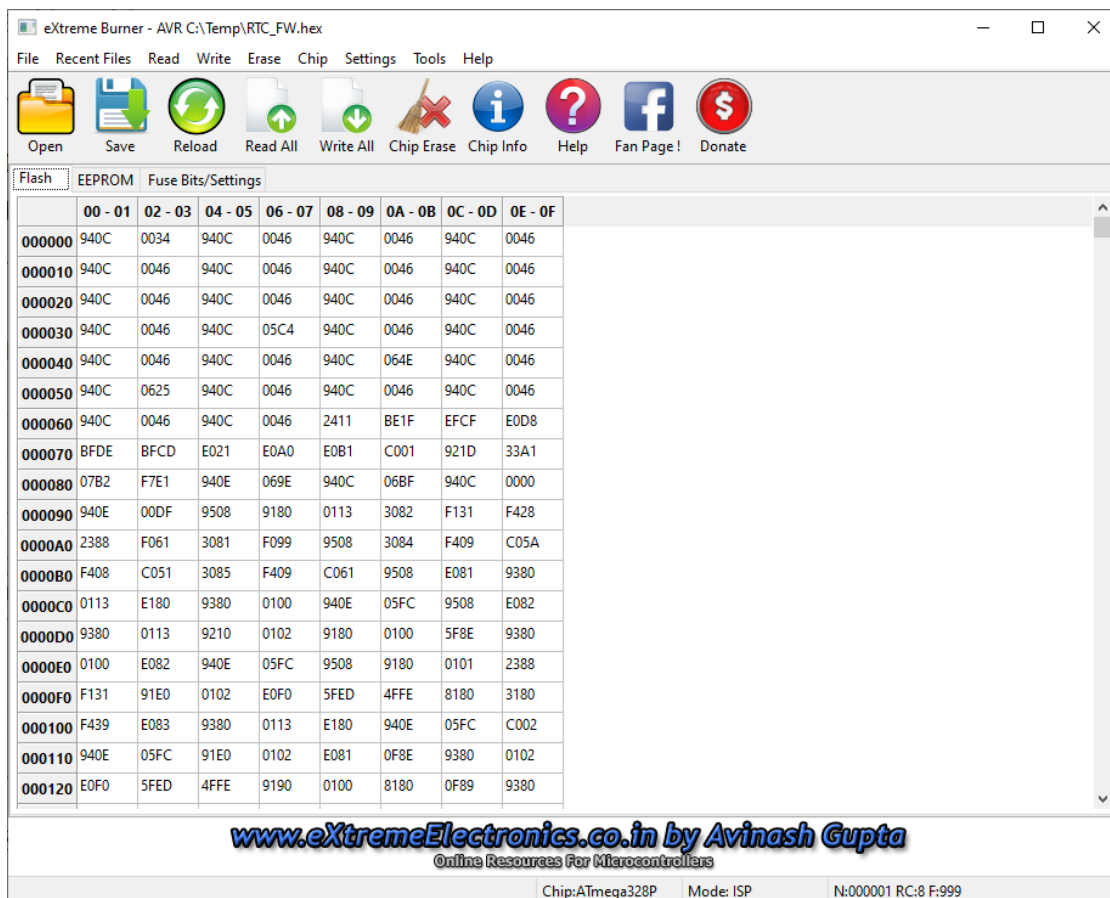

eXtreme Burner tool can be found here: <https://extreme-burner-avr.software.informer.com/>

For programming with the AVRSIP MKII tool, use Atmel Studio 7.x (*Instructions to be detailed later*)

For programming with the Atmel ICE Debugger/Programmer, use Atmel Stdio 7.x (*Instructions to be detailed later*)

3. REMOVAL OF THE ALTERNATE FIRMWARE

Use the ARCOM 2561 Updater tool to install the ARCOM RC210 firmware “1st time init” firmware binary file. Wait for the front panel LED visual indication to indicate that the 1st time initialization sequence has been completed. Then load in the matching RC210 firmware bin file using the 2561 Updater tool.

At this point your RC210 board should now be functioning with the standard ARCOM RC210 firmware (version of your choice). Use the ARCOM RCP windows tool to load in your previously saved configuration data. (*You did save it previously??*)

3.1 Removal of the RTC alternate Firmware

Use the same tool/programmer that you used to re-flash the RTC board with, but instead load the original ARCOM RTC hex file. (RTC_Fw_ARCOM.hex file will be provided for this)

4. RUNTIME ERROR DETECTION

4.1 Configuration Parameter Validation/Startup Indication

When the alternate RC210 firmware starts up, it verifies all the non-volatile configuration parameters stored in eeprom using a 16-bit CRC value. If the stored 16-bit CRC value matches the calculated 16-bit CRC value, then the non-volatile configuration parameters are deemed to be correct. The RC210 front panel COS and CTCC LEDs will indicate the status of the non-volatile configuration parameters validation. It will only be shown for about 1 second on RC210 startup. The following table shows front panel LEDs validation status if the ARCOM RTC board or the custom 24LC256 eeprom board, and (3) DS2433 eeproms are installed. The next table shows it without the RTC/EEP board installed but with the DS2433's installed. The 3rd table shows it with the RTC/EEP board installed, but no DS2433s present. The 4th table shows it without the RTC/EEP board(s) and without DS2433s present.

4.1.1 Validation Results – With RTC/EEP - Hardware Revision 3.5(a)/4.1

Validation Condition:	Green COS #1 LED	Green COS #2 LED	Green COS #3 LED	Yellow CTCSS #1 LED	Yellow CTCSS #2 LED	Yellow CTCSS #3 LED
Valid Configuration, no errors found	ON	ON	ON	OFF	OFF	OFF
Valid Configuration, Primary and Backup were not the same, but Backup has been updated.	ON	ON	ON	OFF	OFF	ON
2561 MCU eeprom was recovered. (Primary or Backup copy)	Flashes, then OFF, then ON		ON (if both are now valid)	ON		OFF
DS2433 eeprom(s) was recovered. (Primary or Backup copy)		Flashes, then OFF, then ON	ON (if both are now valid)		ON	OFF
2561 MCU eeprom failure	OFF		OFF	ON		OFF
DS2433 eeprom(s) failure		OFF	OFF		ON	OFF
MCU eeprom failure and DS2433 eeprom(s) failure	OFF	OFF	OFF	ON	ON	ON

Table 3 –Front Panel Configuration Validation with RTC/EEP & DS2433s

4.1.2 Validation Results – Without RTC/EEP - Hardware Revision 3.5(a)

Validation Condition:	Green COS #1 LED	Green COS #2 LED	Green COS #3 LED	Yellow CTCSS #1 LED	Yellow CTCSS #2 LED	Yellow CTCSS #3 LED
Valid Configuration, no errors found	ON	ON	ON	OFF	OFF	OFF
2561 MCU eeprom failure	OFF		OFF	ON		OFF
DS2433 eeprom(s) failure		OFF	OFF		ON	OFF
MCU eeprom failure and DS2433 eeprom(s) failure	OFF	OFF	OFF	ON	ON	ON

Table 4 –Front Panel Configuration Validation without RTC/EEP but with DS2433s

4.1.3 Validation Results – With RTC/EEP - Hardware Revision 3.3/4.0

Note: If the RC210 hardware is Revision 3.3, then the MCU part was upgraded to the Atmel 2561 part.

Validation Condition:	Green COS #1 LED	Green COS #2 LED	Green COS #3 LED	Yellow CTCSS #1 LED	Yellow CTCSS #2 LED	Yellow CTCSS #3 LED
Valid Configuration, no errors found	ON	OFF	ON	OFF	OFF	OFF
Valid Configuration, Primary and Backup were not the same, but Backup has been updated.	ON	OFF	ON	OFF	OFF	ON
2561/2560 MCU eeprom was recovered. (Primary or Backup copy)	Flashes, then OFF, then ON		ON (if both are now valid)	ON		OFF
2561/2560 MCU eeprom failure	OFF		OFF	ON		OFF

Table 5 –Front Panel Configuration Validation with RTC/EEP without DS2433s

4.1.4 Validation Results – Without RTC/EEP - Hardware Revision 3.3/4.0

Note: If the RC210 hardware is Revision 3.3, then the MCU part was upgraded to the Atmel 2561 part.

Validation Condition:	Green COS #1 LED	Green COS #2 LED	Green COS #3 LED	Yellow CTCSS #1 LED	Yellow CTCSS #2 LED	Yellow CTCSS #3 LED
Valid Configuration, no errors found	ON	OFF	ON	OFF	OFF	OFF
2561/2560 MCU eeprom failure	OFF	OFF	OFF	ON	OFF	ON

Table 6 –Front Panel Configuration Validation without RTC/EEP without DS2433s

4.2 Successful Startup Indication

After the configuration parameters have completed their validation, and if the configuration parameters are correct, and/or have been recovered, the front panel LEDs will all be flashed quickly 100msecs On and Off. This provides an indication of successful startup validation (including possible recovery) and has the side effect of ensuring the LEDs are all working.

4.3 Unsuccessful Startup Indication

If the alternate RC210 firmware fails the non-volatile configuration parameter check, the front panel COS and CTCSS LEDs will flash ON and OFF in an alternate method. This indicates that an unrecoverable problem was found with the non-volatile parameters. The firmware will continue to operate but may operate erratically.

The (voice) startup message sent out on radio port #1 will add extra wording: “*NVM Error*”.

4.4 Parameter Check Failure Runtime Indication

If the non-volatile parameter check had failed, then once about every 60 seconds this error condition will be indicated on the RC210 front panel LEDs by having the COS and CTCSS LEDs do a quick flash ON, and then OFF. (This is like what a residential battery power smoke detector does to indicate its battery is low). It will only do this when the RC210 firmware is idle, and there is no radio port activity. There must have not been any radio port activity for duration of 60 seconds first before it tries to indicate this error condition.

4.5 Parameter Check Failure Parameters Missing

If the non-volatile parameter check fails to find special internal parameters used as a *Presence Detection* mechanism, then the RC210 firmware will operate on a copy of the factory default configuration parameters that is present in flash memory. This allows operation of the RC210 board after a complete eeprom erase operation has been done. It will announce “*NVM Error*” on startup out on radio port #1.

4.6 ARCOM RTC Board Detection

If the RTC board was found on startup, the last ON flash of the 6 COS/CTCSS LEDs will be longer, using duration of 500 milliseconds on time. NOTE: updated firmware must have been loaded onto the RTC board for it to be detected.

4.7 External 24LC256 Eeprom Board Detection

If the optional external 24LC256 eeprom board was found on startup, the last ON flash of the 6 COS/CTCSS LEDs will be longer (using a duration of 500 milliseconds ON time) and will be done twice (instead just once for the RTC board detection).

5. RC210 DTMF COMMANDS SUPPORTED

5.1 Port Configuration (Supervisory) Commands

Name:	DTMF:	Supported:
Port 1 Receiver Enable	1101	Yes
Port 1 Receiver Disable	1100	Yes
Port 2 Receiver Enable	2101	Yes
Port 2 Receiver Disable	2100	Yes
Port 3 Receiver Enable	3101	Yes
Port 3 Receiver Disable	3100	Yes
Port 1 Transmitter Enable	1111	Yes
Port 1 Transmitter Disable	1110	Yes
Port 2 Transmitter Enable	2111	Yes
Port 2 Transmitter Disable	2110	Yes
Port 3 Transmitter Enable	3111	Yes
Port 3 Transmitter Disable	3110	Yes
Port 1 Carrier Only	1120	Yes
Port 1 CTCSS and Carrier	1121	Yes
Port 2 Carrier Only	2120	Yes
Port 2 CTCSS and Carrier	2121	Yes
Port 3 Carrier Only	3120	Yes
Port 4 CTCSS and Carrier	3121	Yes
Port 1 Mute DTMF retransmit ON	1211	Yes
Port 1 Mute DTMF retransmit OFF	1210	Yes
Port 2 Mute DTMF retransmit ON	2211	Yes
Port 2 Mute DTMF retransmit OFF	2210	Yes
Port 3 Mute DTMF retransmit ON	3211	Yes
Port 4 Mute DTMF retransmit OFF	3210	Yes
Port 1 Touchtone Covertone ON	1131	Yes
Port 1 Touchtone Covertone OFF	1130	Yes
Port 2 Touchtone Covertone ON	2131	Yes
Port 2 Touchtone Covertone OFF	2130	Yes
Port 3 Touchtone Covertone ON	3131	Yes
Port 4 Touchtone Covertone OFF	3130	Yes
Port 1 Courtesy Tone Select where x = 1-10	1134x	Yes
Port 2 Courtesy Tone Select where x = 1-10	2134x	Yes
Port 3 Courtesy Tone Select where x = 1-10	3134x	Yes
Port 1 Kerchunk Filter ON	1151	Yes
Port 1 Kerchunk Filter OFF	1150	Yes
Port 2 Kerchunk Filter ON	2151	Yes
Port 2 Kerchunk Filter OFF	2150	Yes
Port 3 Kerchunk Filter ON	3151	Yes
Port 3 Kerchunk Filter OFF	3150	Yes
Port 1 Repeating	1141	Yes
Port 1 Non-Repeating	1140	Yes
Port 2 Repeating	2141	Yes

Port 2 Non-Repeating	2140	Yes
Port 1 Monitor Audio Mix	1191	Yes
Port 1 Monitor Audio Mute	1190	Yes
Port 2 Monitor Audio Mix	2191	Yes
Port 2 Monitor Audio Mute	2190	Yes
Port 3 Monitor Audio Mix	3191	Yes
Port 3 Monitor Audio Mute	3190	Yes
Port 1 Speech Override ON	1201	Yes
Port 1 Speech Override OFF	1200	Yes
Port 2 Speech Override ON	2201	Yes
Port 2 Speech Override OFF	2200	Yes
Port 3 Speech Override ON	3201	Yes
Port 3 Speech Override OFF	3200	Yes
Port 1 Speech ID Override ON	1181	Yes
Port 1 Speech ID Override OFF	1180	Yes
Port 2 Speech ID Override ON	2181	Yes
Port 2 Speech ID Override OFF	2180	Yes
Port 3 Speech ID Override ON	3181	Yes
Port 3 Speech ID Override OFF	3180	Yes
Port 1 DTMF Enable	1161	Yes
Port 1 DTMF Disable	1160	Yes
Port 2 DTMF Enable	2161	Yes
Port 2 DTMF Disable	2160	Yes
Port 3 DTMF Enable	3161	Yes
Port 4 DTMF Disable	3160	Yes
Port 1 CTCSS not required for DTMF	1170	Yes
Port 1 CTCSS required for DTMF	1171	Yes
Port 2 CTCSS not required for DTMF	2170	Yes
Port 2 CTCSS required for DTMF	2171	Yes
Port 3 CTCSS not required for DTMF	3170	Yes
Port 3 CTCSS required for DTMF	3171	Yes
Port 1 DTMF evaluate on CTCSS closure	1221	Yes
Port 1 DTMF evaluate on COS closure	1220	Yes
Port 2 DTMF evaluate on CTCSS closure	2221	Yes
Port 2 DTMF evaluate on COS closure	2220	Yes
Port 3 DTMF evaluate on CTCSS closure	3221	Yes
Port 3 DTMF evaluate on COS closure	3220	Yes

5.1.1 Note on setting up DTMF Evaluation On COS/CTCSS Closure

When setting up the port configuration parameter (X221/X220) to specify when to evaluate DTMF commands, it needs to be set up according to how your repeater uses COS and CTCSS signaling. If the repeater drops CTCSS signal first, before dropping COS (fairly normal), then you need to set up DTMF evaluation on CTCSS closure (on TONE closure). If this is set wrong, you could get the courtesy tone being transmitted before the DTMF command's spoken words, or no courtesy tone sent out. If this happens, change the setting for DTMF evaluation on XX to the other choice.

5.2 Port Linking Commands

Name:	DTMF:	Supported:
Monitor Port 2 from Port 1 ON	1301	Yes
Monitor Port 2 from Port 1 OFF	1300	Yes
Monitor Port 3 from Port 1 ON	1311	Yes
Monitor Port 3 from Port 1 OFF	1310	Yes
Monitor Port 1 from Port 2 ON	2301	Yes
Monitor Port 1 from Port 2 OFF	2300	Yes
Monitor Port 3 from Port 2 ON	2311	Yes
Monitor Port 3 from Port 2 OFF	2310	Yes
Monitor Port 1 from Port 3 ON	3301	Yes
Monitor Port 1 from Port 3 OFF	3300	Yes
Monitor Port 2 from Port 3 ON	3311	Yes
Monitor Port 2 from Port 3 OFF	3310	Yes
Link Port 1 to Port 2	A11	Yes
Unlink Port 1 from Port 2	A10	Yes
Link Port 1 to Port 3	A21	Yes
Unlink Port 1 from Port 3	A20	Yes
Link Port 2 to Port 3	A31	Yes
Unlink Port 2 from Port 3	A30	Yes
Link all Ports to all other Ports	A41	Yes
Unlink all Ports from all other Ports	A40	Yes
Interrogate Port 1 Status	1401	
Interrogate Port 2 Status	1402	
Interrogate Port 3 Status	1403	

5.3 Auxiliary Audio Inputs

Name:	DTMF:	Supported:
Turn Auxiliary Audio Input 1 ON	1961	
Turn Auxiliary Audio Input 1 OFF	1960	
Turn Auxiliary Audio Input 2 ON	2961	
Turn Auxiliary Audio Input 2 OFF	2960	
Turn Auxiliary Audio Input 3 ON	3961	
Turn Auxiliary Audio Input 3 OFF	3960	

5.4 General Logic Outputs

Name:	DTMF:	Supported:
Logic Output 1 Open Drain	1810	Yes
Logic Output 1 Low	1811	Yes
Logic Output 1 Pulsed (open, low, open)	1812	Yes
Logic Output 2 Open Drain	1820	Yes
Logic Output 2 Low	1821	Yes
Logic Output 2 Pulsed (open, low, open)	1822	Yes
Logic Output 3 Open Drain	1830	Yes
Logic Output 3 Low	1831	Yes
Logic Output 3 Pulsed (open, low, open)	1832	Yes
Logic Output 4 Open Drain	1840	Yes
Logic Output 4 Low	1841	Yes
Logic Output 4 Pulsed (open, low, open)	1842	Yes
Logic Output 5 Open Drain	1850	Yes
Logic Output 5 Low	1851	Yes
Logic Output 5 Pulsed (open, low, open)	1852	Yes
Logic Output 6 Open Drain	1860	Yes
Logic Output 6 Low	1861	Yes
Logic Output 6 Pulsed (open, low, open)	1862	Yes
Logic Output 7 Open Drain	1870	Yes
Logic Output 7 Low	1871	Yes
Logic Output 7 Pulsed (open, low, open)	1872	Yes
<i>The following commands where NOT in the ARCOM RC210 firmware:</i>		
Logic Output 8 Open Drain	1880	Yes
Logic Output 8 Low	1881	Yes
Logic Output 8 Pulsed (open, low, open)	1882	Yes

5.5 Extended Logic Outputs

Not yet supported.

5.6 Analog Meter Inputs

Name:	DTMF:	Supported:
Readback current value	1400 (1-8)	Yes
Readback stored LOW value	1400 (1-8) 1	Yes
Readback stored HIGH value	1400 (1-8) 2	Yes

5.7 Digital Temperature Sensor Inputs

Name:	DTMF:	Supported:
Readback current digital temperature value. The 5th digit indicates which logical temperature sensor to read from (1-4)	1410(1-4)	Yes
Readback LOWest digital temperature value. The 5th digit indicates which logical temperature sensor to read from (1-4)	1410(1-4) 1	Yes
Readback HIGHest digital temperature value. The 5th digit indicates which logical temperature sensor to read from (1-4)	1410(1-4) 2	Yes
Readback PREVIOUSly read digital temperature sensor value. The 5th digit indicates which logical temperature sensor to read from (1-4)	1410(1-4) 3	Yes

5.8 Digital Temperature Sensor I/O Pin Input Selection

Name:	DTMF:	Supported:
Select which I/O pin is used for output to the Digital temperature sensor interface board.	1420x x = pin #	Yes
Select which I/O pin is used for input to the Digital temperature sensor interface board.	1421x x = pin #	Yes

The value for **x**, is used to indicate which RC210 I/O connector pin number to use for output and for input. Your choices are from pins numbered 1 to 8. This directly corresponds which the RC210 I/O DB25 connector pin numbers. The default setting for these pins is pin 1 for output and pin 2 for input. This matches the RC210 analog input pins which can have the optional 4K7 pull-up resistor soldered onto the pcb.

5.9 Digital Temperature Sensor Background Reading Enable

Name:	DTMF:	Supported:
Disable background digital temperature sensor reading.	14300	Yes
Enable background digital temperature sensor reading. Runs once a minute.	14301	Yes

Note: Background reading of the digital temperature sensors is NOT enabled by default on firmware powerup. It must be enabled to use this feature.

5.10 Meter Alarms

Name:	DTMF:	Supported:
1 to 8 Meter Alarms	1600xy x = 1 to 8 y = 1 for ON y = 0 for OFF	Yes

5.11 Logic Alarms

Name:	DTMF:	Supported:
Alarm 1 Enabled	1911	Yes
Alarm 1 Disabled	1910	Yes
Alarm 1 Interrogate	1913	Yes
Alarm 2 Enabled	2911	Yes
Alarm 2 Disabled	2910	Yes
Alarm 2 Interrogate	2913	Yes
Alarm 3 Enabled	3911	Yes
Alarm 3 Disabled	3910	Yes
Alarm 3 Interrogate	3913	Yes
Alarm 4 Enabled	4911	Yes
Alarm 4 Disabled	4910	Yes
Alarm 4 Interrogate	4913	Yes
Alarm 5 Enabled	5911	Yes
Alarm 5 Disabled	5910	Yes
Alarm 5 Interrogate	5913	Yes

5.12 Davis Instruments Weather Station

Not supported.

5.13 Remote Base Operation

Not Supported.

5.14 Doug Hall RBI-1

Not Supported.

5.15 AutoPatch Operation

Not Supported.

5.16 Command Macros

Macros 1 to 90 are supported. Macros 1-50 are supported on the base RC210 v3.5(a) board. Macros 51-90 are supported if the RC210 board has the three DS2433 eeprom chips installed. For RC210 boards v4.0 and 4.1 that only have the single DS2433 eeprom chip installed, Macros 51 – 55 are supported.

Macros 91 to 105 are not supported at this time.

5.17 Macro Subset

Not supported.

5.18 Startup Macro

Macro #1 is executed on startup.

5.19 Message Macros

Message macros 1 to 70 are supported. Message Macros 1-40 are supported on the base RC210 v3.5(a) board. Message Macros 41-70 are supported if the RC210 v3.5(a) board has the three DS2433 eeprom chips installed. For RC210 boards v4.0 and 4.1 that only have the single DS2433 eeprom chip installed, Message Macros 41 – 55 are supported.

5.20 ID Extras

Supported. *8007x yy where “x” is the voice ID number of the unlocked port, “yy” is the extra ID message to use:

ID Extra #	Meaning:
0	Cancel ID Extras
1	Say Good M/A/E BEFORE the ID
2	Say Good MA/E AFTER the ID
3	Say the Time BEFORE the ID
4	Say the Time AFTER the ID
5	Say Good M/A/E and the Time BEFORE the ID
6	Say Good M/A/E and the Time AFTER the ID
7	Say Good M/A/E BEFORE the ID and say the Time AFTER the ID
8	Say the Time BEFORE the ID and Good M/A/E AFTER the ID
9	Say the Time and Good M/A/E BEFORE the ID
10	Say the Time and Good M/A/E AFTER the ID
11	Random rotation of 1 through 10

Table 7 – Voice ID Extras

NOTE: The ID Extra setting will apply to both Initial and Pending Voice IDs.

5.21 ID Extra Special Functions

As of RC210 firmware vA1.06, ID Extra Special functions are not yet supported with DTMF commands. They are only supported via the RC210_CFG program. ID Extra Special functions coexist with the normal ID Extras. They are added to the end of any Voice ID:

- Say a notice if any NVM parameter storage area was recovered or restored.
- Say the current status of all NVM configuration parameters.

5.22 IRLP / Echolink DTMF Regeneration

Not yet Supported.

5.23 Digital Voice Recorder (DVR)

The DVR track recoding support allows up to 20 DVR “tracks” to be recorded. The free recording space inside the ISD4003 recoding chip is used to hold DVR track audio. DVR tracks can be used in Voice ID’s and Message macros. NOTE: if the NVM parameters are erased, any recorded DVR Track(s) will be erased too.

Name:	DTMF:	Supported:
Record DVR Track. “x” is the DVR track number you wish to record (1-20)	*7001x	Yes
Play a DVR Track “x” id the DVR track to play (1-20)	123x	Yes
Erase a DVR Track “x” is the DVR track to be erased (1-20)	*7002x	Yes
Erase all DVR Tracks	*7003	Yes
Edit Recorded DVR Track – Remove a portion “x” is the DVR track to be edited (1-20)	*7004x	Yes
Edit Recorded DVR Track – Recover a portion “x” is the DVR track to be edited (1-20)	*7005x	Yes
Available Free recording space (in seconds)	*7006	Yes

5.23.1 DVR Recording

***7001x** where “x” is the track number to be recorded (1-20). The controller will respond with the number of free recording space in seconds, than say “READY”. It is now waiting for you to key your radio and speak the desired DVR track recoding audio. You have 5 seconds to key your radio before the DVR track record operation “times-out” and it is cancelled. Once you un-key your radio the record operation is complete.

5.23.2 DVR Playing

123x where “x” is the track number to play (1-20).

5.23.3 DVR Track Erase

***7002x** where “x” is the track number to erase (1-20). Note: Only the last written DVR track being erased will free-up DVR recording space. If other tracks where previously recorded, the specified track will be logically “erased”, but it’s storage space is not recovered. See the command to erase all DVR tracks to free up all DVR track recording space.

5.23.4 DVR All Tracks Erase

***7003**. This will erase all DVR tracks and free-up all DVR recording space.

5.23.5 DVR Track Edit

***7004x** where “x” is the track number to edit. This will remove a single “segment” from the end of a previously recorded audio track. You can only remove as many as the number of segment that makes up the entire audio track. See the DVR recoding segment table to identify the actual time segment depending upon the type of ISD chip you have installed in your RC210.

***7005x** where “x” is the track number to edit. This will add back a previously removed single “segment” to the end of a previously recorded audio track. You can only add back in as many as the number of segment that makes up the entire audio track. See the DVR recoding segment table to identify the actual time segment depending upon the type of ISD chip you have installed in your RC210.

ISD4003 Chip Installed:	Time Segment:
ISD4003-04M	200 milliseconds (.200 seconds)
ISD4003-05M	250 milliseconds (.250 seconds)
ISD4003-06M	300 milliseconds (.300 seconds)
ISD4003-08M	400 milliseconds (.400 seconds)

Table 8 –ISD4003 Voice Record IC Time Segment Types

Be sure to speak immediately when you start transmitting to minimize the amount of DVR recording space used. You can only edit the end of a DVR track.

5.23.6 Free Recording Time Left

***7006.** Will speak the number of seconds of free DVR track recording time left.

5.24 General Timers

Name:	DTMF:	Supported:
Program General Timer. x = timer number (1-6) y = number of seconds (1-32767)	*1017xy	Yes
Setup command macro to run from timer X = timer number (1-6) Y = command macro number to run (1-90)	*2092xy	Yes

5.25 Real Time Clock and Calendar

Supported, but to use the RTC option board, replacement RTC firmware will need to be installed. If you do not upgrade the RTC board firmware, the alternate RC210 firmware will not recognize the presence of the RTC board.

Name:	DTMF:	Supported:
Set RTC Time. hh = hours in 24-hour time format mm = minutes ss = seconds (optional)	*5100hhmm[ss]	Yes
Set RTC Calendar. Mm = month Dd = day Yy = year (+2000 assumed)	*5101mmddy	Yes
Disable Year readback	*51020	Yes
Enable Year readback	*51021	Yes
Select 12-hour readback	*51030	Yes
Select 24-hour readback	*51031	Yes
Select Hours to be spoken	*51041	Yes
Do not speak hours	*51040	Yes
Add correction factor to RTC Add "A" to subtract seconds x = number of seconds	*5105<A>x	
Set DST Start Month mm = starting month (01-12) s = Sunday in the month (1-5)	*21311mms	
Set DST End Month mm = ending month (01-12) s = Sunday in the month (1-5)	*21310mms	
Set DST Start Hour yy = start hour (00-23)	*21321yy	
Set DST End Hour yy = ending hour (00-23)	*21322yy	
Announce current Time	1700	Yes
Announce current Date	1701	Yes

5.26 Support for Unlocked Port Commands

The following commands will only affect the currently “unlocked” radio port.

5.27 Unlock Code Programming

Name:	DTMF:	Supported:
Port 1 Default Unlock Code	15281	Yes
Port 2 Default Unlock Code	25281	Yes
Port 3 Default Unlock Code	35281	Yes
Program UnLock Code (up to 8 digits)	*9000ddddddd	Yes
Program Lock Code (up to 4 digits)	*9010xxxx	Yes

5.28 Pre Command Prefix

Not supported.

5.29 DTMF Pre Access Code

Name:	DTMF:	Supported:
Program DTMF Pre-Access Code. Where: <i>ddd</i> is from 1 to 3 digits. NOTE: only send * 2108 to erase the DTMF Pre-Access code.	*2108ddd	Yes

Note: The DTMF Pre-Access code also applies to the DTMF Test Pad Prefix. This means that if there is a DTMF Pre-Access code set, then it will need to be used / added to the DTMF Test Pad Prefix code too.

Note: The DTMF Pre-Access Range command is also required to be setup for the DTMF Pre-Access code to be in effect.

5.30 DTMF Pre Access Range

Name:	DTMF:	Supported:
Program DTMF Pre-Access Range. Where: XXy is from 1 to 3 digits and is the decimal START Macro number to (range) include. YYy is from 1 to 3 digits and is the decimal END macro number to include in the range. NOTE: only send * 40200000 to remove the DTMF Pre-Access range. (This will make the DTMF Pre-Access Code not useable)	*4020XXxYYy	Yes

Note: The DTMF Pre-Access Range command is required to be setup for the DTMF Pre-Access code to be in effect.

5.31 Locking (Leaving Program Mode)

Supported.

5.32 Programming a Custom Lock Code

Name:	DTMF:	Supported:
Program UnLock Code (up to 8 digits)	*9000ddddddd	Yes
Program Lock Code (up to 4 digits)	*9010xxxx	Yes

5.33 Programming a Custom Terminator Digit

Name:	DTMF:	Supported:
Program Custom Terminator Digit (x=digit)	9020x	Yes

5.34 Port Timer Programming

Name:	DTMF:	Supported:
Hang Time. y = hang timer 1-3 xxxx = time in 1/10 seconds	*1000yxxx	Yes
Time Out Timer. xxxxx = time out period (1-32767 seconds)	*1001xxxxx	Yes
Time Out Reset Timer. xxx = 1-250 .1 second increments	*1009xxx	Yes
Initial ID Timer. xxx = 1 to 255 minutes	*1002xxx	Yes
Pending ID Timer. xxx = 1 to 255 minutes	*1003xxx	Yes
Fan Timer. xxx = 1-255 minutes	*1004xxx	Yes
Port Inactivity Timer. Xxx = 1 to 255 minutes	*1005xxx	Yes
DTMF Mute Timer Xxx = 1 to 255 100msec increments	*1006xxx	Yes
CTCSS Encode Drop-Out Timer. Xxx = 0 to 255 in 100 msec increments	*1007xxx	Yes
Kerchunk Timer. Xxxx = 1 to 6000 in 1msec increments	*1018xxxx	Yes
Kerchunk Timeout Timer. Xxx = 0 to 255 seconds	*1008xxx	Yes
Auxiliary Audio Input 1 Timer	*1013x	
Auxiliary Audio Input 1 Timer	*1014x	
Auxiliary Audio Input 1 Timer	*1015x	
Pending ID Speech Timer. xxx = 1 to value of Pending ID timer in seconds	*1019xxx	Yes
Tail Message Timer. xxx = 0 to 999 seconds	*1020xxx	Yes

5.35 CTCSS Encode Control Programming

Name:	DTMF:	Supported:
CTCSS Encode Control Line Polarity x = 1 then output will float x = 0 then output will pull to ground	*1021x	Yes
CTCSS Encode start after COS or after CT x = 1 after courtesy tone x = 0 after COS closure	*2088x	Yes
CTCSS Encode During ID's x = 1 send CTCSS during IDs x = 0 do not send CTCSS during IDs	*2089x	Yes

5.36 Miscellaneous Programming

Name:	DTMF:	Supported:
Linked Port(s) ID Triggering Enable (ON)	*20911	Yes
Linked Port(s) ID Triggering Disable (OFF)	*20912	Yes
DTMF Mute Digit x = 1 to mute on 1 st digit x = 2 to mute on 2 nd digit	*2090x	Yes
Delay Before Speech/CW Starts X = amount of delay time in msec to delay (0-32767)	*1022x	Yes
DTMF Test Pad Prefix x = 1 to 5 digits to use for the prefix	*2093x	Yes
Speak Firmware Version Number	*299999	Yes
Timeout between linked ports x = 0 if port tx timeout occurs only when timeout occurs on itself x =1 if port tx timeout occurs on itself or activity on any linked port exceeds the timeout timer	*2051x	
Linking Ports Timeout Timer Reset Point x = 0 after COS x = 1 after CT segment 1 x = 2 after CT segment 2 x = 3 after CT segment 3 x = 4 after CT segment 4	*2122x	
Start Fan on any transmitter activity	*21191	
Start Fan on receiver, autopatch, or aux audio activity	*21190	
Use Detailed Voice Responses	*21351	
Use CW Response – ‘R’ = good ‘?’ = error	*21350	
<DTMF Pad Test Prefix><up to 16 digits> Note: DTMF Pre-Access command WILL apply to this.		Yes

5.37 Remote Base Programming

Not supported.

5.38 Port Inactivity Macro

Name:	DTMF:	Supported:
Port Inactivity Macro x = command macro to run (1 – 90)	*2114x	Yes

5.39 Command Macros

Name:	DTMF:	Supported:
Program Command Macro # mmm = macro number fff = macro function	*4002<mmm> fff	Yes
ReMap Controller Functions mmm = macro number cccc = dtmf code digits	*2050 <mmm> cccc	Yes

5.39.1 Command Macro Priority

Not supported.

5.39.2 Startup Macro

Macro #1 is executed on startup.

5.39.3 Macro Subset (Guest Macros)

Name:	DTMF:	Supported:
Program Macro Subset	*4009xxx yyy	No

5.39.4 Determine Contents of a Command Macro

Name:	DTMF:	Supported:
Speak macro contents “x” = macro number	*4008x	Yes

5.39.5 Erase Command Macros

Name:	DTMF:	Supported:
Erase Command Macro “x” = command macro number	*4003x	Yes
Erase all macros	*400499	

5.39.6 Receiver Macro Functions

Name:	DTMF:	Supported:
Port Macro to call on receiver going active mm = Macro number to call on receive going activate	*2113 1 mm	Yes
Port Macro to call on receiver going inactive mm = Macro number to call on receive going inactive	*2113 0 mm	Yes

Note: To use Receiver macros, you MUST enable them via a macro command. See Macro functions: 358-363.

5.39.7 Control Command Macros Accessed by Port

Name:	DTMF:	Supported:
Which ports will allow command macros. xxx = command macro number yyy = Port number: 1 – Port 1 2 – Port 2 3 – Port 3 12 – Ports 1 & 2 13 – Ports 1 & 3 23 – Ports 2 & 3 123 – All Ports	*4005 xxx yyy	Yes
Erase all Command macros Port Restrictions	*400699	Yes

5.39.8 Message Macros

Name:	DTMF:	Supported:
Program a Message Macro MM = message macro number V1 – Vocabulary word #1 to use V2 = Vocabulary word #2 to use V.. = additional vocabulary words to use	*2103 MM v1 v2 v..	Yes

5.39.9 Speech Control Within Command Macros

Supported. The following Macro Functions are used to control speech-port direction:

- 162 Port1
- 163 Port 2
- 164 Port 3
- 165 Port 1 & 2
- 166 Port 1 & 3
- 167 Port 2 7 3
- 168 All Ports
- 251 Force Audio to entered port

These speech control macro functions do double-duty. They are also used when executing the CTCSS Encode macro support functions: 85, 86, 304, 305, 552, and 553. When used with these CTCSS Encode macro function numbers, they will select which radio port that the CTCSS Encode macro support function applies to.

5.39.10 Macro Function Number List

The following list of Macro Function numbers that are **Grayed out** are not supported.

<u>FN</u>	<u>Description</u>	<u>FN</u>	<u>Description</u>
1	Port 1 CTCSS Access	61	Port 2 Courtesy Tone 3
2	Port 2 CTCSS Access	62	Port 2 Courtesy Tone 4
3	Port 3 CTCSS Access	63	Port 2 Courtesy Tone 5
4	Port 1 Carrier Access	64	Port 2 Courtesy Tone 6
5	Port 2 Carrier Access	65	Port 2 Courtesy Tone 7
6	Port 3 Carrier Access	66	Port 2 Courtesy Tone 8
7	Port 1 DTMF Covertone ON	67	Port 2 Courtesy Tone 9
8	Port 2 DTMF Covertone ON	68	Port 2 Courtesy Tone 10
9	Port 3 DTMF Covertone ON	69	Port 3 Courtesy Tone 1
10	Port 1 DTMF Covertone OFF	70	Port 3 Courtesy Tone 2
11	Port 2 DTMF Covertone OFF	71	Port 3 Courtesy Tone 3
12	Port 3 DTMF Covertone OFF	72	Port 3 Courtesy Tone 4
13	Port 1 TX Enable	73	Port 3 Courtesy Tone 5
14	Port 2 TX Enable	74	Port 3 Courtesy Tone 6
15	Port 3 TX Enable	75	Port 3 Courtesy Tone 7
16	Port 1 TX Disable	76	Port 3 Courtesy Tone 8
17	Port 2 TX Disable	77	Port 3 Courtesy Tone 9
18	Port 3 TX Disable	78	Port 3 Courtesy Tone 10
19	Monitor Port 1 from Port 2	79	Port 1 DTMF Muting ON
20	Monitor Port 1 from Port 3	80	Port 2 DTMF Muting ON
21	Disconnect Port 1 from Port 2	81	Port 3 DTMF Muting ON
22	Disconnect Port 1 from Port 3	82	Port 1 DTMF Muting OFF
23	Monitor Port 2 from Port 1	83	Port 2 DTMF Muting OFF
24	Monitor Port 2 from Port 3	84	Port 3 DTMF Muting OFF
25	Disconnect Port 2 from Port 1	85	CTCSS Encode ON (for the duration of this Macro)
26	Disconnect Port 2 from Port 3	86	CTCSS Encode OFF (for the duration of this Macro)
27	Monitor Port 3 from Port 1	87	Read ADC Channel 1
28	Monitor Port 3 from Port 2	88	Read ADC Channel 2
29	Disconnect Port 3 from Port 1	89	Read ADC Channel 3
30	Disconnect Port 3 from Port 2	90	Read ADC Channel 4
31	Port 1 Monitor Mute	91	Read ADC Channel 5
32	Port 2 Monitor Mute	92	Read ADC Channel 6
33	Port 3 Monitor Mute	93	Read ADC Channel 7
34	Port 1 Monitor Mix	94	Read ADC Channel 8
35	Port 2 Monitor Mix	95	UF1 ON
36	Port 3 Monitor Mix	96	UF2 ON
37	Port 1 Repeat ON	97	UF3 ON
38	Port 2 Repeat ON	98	UF4 ON
39	Port 3 Repeat ON	99	UF5 ON
40	Port 1 Repeat OFF	100	UF6 ON
41	Port 2 Repeat OFF	101	UF7 ON
42	Port 3 Repeat OFF	102	UF1 OFF
43	Port 1 Speech Override ON	103	UF2 OFF
44	Port 2 Speech Override ON	104	UF3 OFF
45	Port 3 Speech Override ON	105	UF4 OFF
46	Port 1 Speech Override OFF	106	UF5 OFF
47	Port 2 Speech Override OFF	107	UF6 OFF
48	Port 3 Speech Override OFF	108	UF7 OFF
49	Port 1 Courtesy Tone 1	109	UF1 Pulse
50	Port 1 Courtesy Tone 2	110	UF2 Pulse
51	Port 1 Courtesy Tone 3	111	UF3 Pulse
52	Port 1 Courtesy Tone 4	112	UF4 Pulse
53	Port 1 Courtesy Tone 5	113	UF5 Pulse
54	Port 1 Courtesy Tone 6	114	UF6 Pulse
55	Port 1 Courtesy Tone 7	115	UF7 Pulse
56	Port 1 Courtesy Tone 8	116	Say Time
57	Port 1 Courtesy Tone 9	117	Say Date
58	Port 1 Courtesy Tone 10	118	Link Port 1 to Port 2
59	Port 2 Courtesy Tone 1		
60	Port 2 Courtesy Tone 2		

<u>FN</u>	<u>Description</u>	<u>FN</u>	<u>Description</u>
119	Link Port 1 to Port 3	181	Force Next Voice ID In Rotation On Port 1
120	Link Port 2 to Port 3	182	Force Next Voice ID In Rotation On Port 2
121	Link All Ports	183	Force Next Voice ID In Rotation On Port 3
122	Unlink Port 1 from Port 2	184	Force Next CW ID In Rotation On Port 1
123	Unlink Port 1 from Port 3	185	Force Next CW ID In Rotation On Port 2
124	Unlink Port 2 from Port 3	186	Force Next CW ID In Rotation On Port 3
125	UnLink All Ports	187	Play Message Macro 1
126	Play DVR Track 1	188	Play Message Macro 2
127	Play DVR Track 2	189	Play Message Macro 3
128	Play DVR Track 3	190	Play Message Macro 4
129	Play DVR Track 4	191	Play Message Macro 5
130	Play DVR Track 5	192	Play Message Macro 6
131	Play DVR Track 6	193	Play Message Macro 7
132	Play DVR Track 7	194	Play Message Macro 8
133	Play DVR Track 8	195	Play Message Macro 9
134	Play DVR Track 9	196	Play Message Macro 10
135	Play DVR Track 10	197	Play Message Macro 11
136	Play DVR Track 11	198	Play Message Macro 12
137	Play DVR Track 12	199	Play Message Macro 13
138	Play DVR Track 13	200	Play Message Macro 14
139	Play DVR Track 14	201	Play Message Macro 15
140	Play DVR Track 15	202	Play Message Macro 16
141	Play DVR Track 16	203	Play Message Macro 17
142	Play DVR Track 17	204	Play Message Macro 18
143	Play DVR Track 18	205	Play Message Macro 19
144	Play DVR Track 19	206	Play Message Macro 20
145	Play DVR Track 20	207	Play Message Macro 21
146	Auxiliary Audio 1 ON	208	Play Message Macro 22
147	Auxiliary Audio 2 ON	209	Play Message Macro 23
148	Auxiliary Audio 3 ON	210	Play Message Macro 24
149	Auxiliary Audio 1 OFF	211	Play Message Macro 25
150	Auxiliary Audio 2 OFF	212	Play Message Macro 26
151	Auxiliary Audio 3 OFF	213	Play Message Macro 27
152	Alarm 1 ON	214	Play Message Macro 28
153	Alarm 2 ON	215	Play Message Macro 29
154	Alarm 3 ON	216	Play Message Macro 30
155	Alarm 4 ON	217	Play Message Macro 31
156	Alarm 5 ON	218	Play Message Macro 32
157	Alarm 1 OFF	219	Play Message Macro 33
158	Alarm 2 OFF	220	Play Message Macro 34
159	Alarm 3 OFF	221	Play Message Macro 35
160	Alarm 4 OFF	222	Play Message Macro 36
161	Alarm 5 OFF	223	Play Message Macro 37
162	Speech Out Port 1	224	Play Message Macro 38
163	Speech Out Port 2	225	Play Message Macro 39
164	Speech Out Port 3	226	Play Message Macro 40
165	Speech Out Ports 1 & 2	227	Good Morning/Afternoon/Evening Runtime Variable
166	Speech Out Ports 1 & 3	228	Macro Priority High
167	Speech Out Ports 2 & 3	229	Macro Priority Low
168	Speech Out All Ports	230	Enable Kerchunk Filter Port 1
169	DTMF Enable Port 1	231	Enable Kerchunk Filter Port 2
170	DTMF Enable Port 2	232	Enable Kerchunk Filter Port 3
171	DTMF Enable Port 3	233	Disable Kerchunk Filter Port 1
172	DTMF Disable Port 1	234	Disable Kerchunk Filter Port 2
173	DTMF Disable Port 2	235	Disable Kerchunk Filter Port 3
174	DTMF Disable Port 3	236	Enable Receiver Port 1
175	DTMF Require CTCSS Port 1	237	Enable Receiver Port 2
176	DTMF Require CTCSS Port 2	238	Enable Receiver Port 3
177	DTMF Require CTCSS Port 3	239	Disable Receiver Port 1
178	DTMF Not Require CTCSS Port 1	240	Disable Receiver Port 2
179	DTMF Not Require CTCSS Port 2	241	Disable Receiver Port 3
180	DTMF Not Require CTCSS Port 3		

<u>FN</u>	<u>Description</u>	<u>FN</u>	<u>Description</u>
242	Port 1 Speech ID Override ON	298	Disable Meter 3 Alarm
243	Port 2 Speech ID Override ON	299	Disable Meter 4 Alarm
244	Port 3 Speech ID Override ON	300	Disable Meter 5 Alarm
245	Port 1 Speech ID Override OFF	301	Disable Meter 6 Alarm
246	Port 2 Speech ID Override OFF	302	Disable Meter 7 Alarm
247	Port 3 Speech ID Override OFF	303	Disable Meter 8 Alarm
248	All Courtesy Tones OFF Port 1	304	CTCSS Encode Force OFF
249	All Courtesy Tones OFF Port 2	305	CTCSS Encode to Programmed Value
250	All Courtesy Tones OFF Port 3	306	Bump Clock By Correction Factor
251	Force Audio To Entered Port	307	Say year as part of date
252	Stop ID/Disable Timeout Timer Port 1	308	Don't say year as part of date
253	Stop ID/Disable Timeout Timer Port 2	309	Port 1 Tail Message OFF
254	Stop ID/Disable Timeout Timer Port 3	310	Port 2 Tail Message OFF
256	Resume ID/Enable Timeout Timer Port 1	311	Port 3 Tail Message OFF
257	Resume ID/Enable Timeout Timer Port 2	312	Port 1 Tail Message 1
258	Resume ID/Enable Timeout Timer Port 3	313	Port 2 Tail Message 1
259	Send DTMF Memory 1	314	Port 3 Tail Message 1
260	Send DTMF Memory 2	315	Port 1 Tail Message 2
261	Send DTMF Memory 3	316	Port 2 Tail Message 2
262	Send DTMF Memory 4	317	Port 3 Tail Message 2
263	Send DTMF Memory 5	318	Port 1 Tail Message 3
264	Send DTMF Memory 6	319	Port 2 Tail Message 3
265	Send DTMF Memory 7	320	Port 3 Tail Message 3
266	Send DTMF Memory 8	321	Remote Base Memory 1
267	Send DTMF Memory 9	322	Remote Base Memory 2
268	Send DTMF Memory 10	323	Remote Base Memory 3
269	Send DTMF Memory 11	324	Remote Base Memory 4
270	Send DTMF Memory 12	325	Remote Base Memory 5
271	Send DTMF Memory 13	326	Remote Base Memory 6
272	Send DTMF Memory 14	327	Remote Base Memory 7
273	Send DTMF Memory 15	328	Remote Base Memory 8
274	Send DTMF Memory 16	329	Remote Base Memory 9
275	Send DTMF Memory 17	330	Remote Base Memory 10
276	Send DTMF Memory 18	331	Port 1 Zero Hang Time Select
277	Send DTMF Memory 19	332	Port 2 Zero Hang Time Select
278	Send DTMF Memory 20	333	Port 3 Zero Hang Time Select
279	Clear All Meter Hi/Low Readings	334	Reserved For Future Use
280	Clear Meter 1 Hi/Low Readings	335	Reserved For Future Use
281	Clear Meter 2 Hi/Low Readings	336	Autodial 911
282	Clear Meter 3 Hi/Low Readings	337	Allow Autopatch from programmed Ports
283	Clear Meter 4 Hi/Low Readings	338	Disable Autopatch
284	Clear Meter 5 Hi/Low Readings	339	Enable Speech ID's Port 1
285	Clear Meter 6 Hi/Low Readings	340	Enable Speech ID's Port 2
286	Clear Meter 7 Hi/Low Readings	341	Enable Speech ID's Port 3
287	Clear Meter 8 Hi/Low Readings	342	Disable Speech ID's Port 1
288	Enable Meter 1 Alarm	343	Disable Speech ID's Port 2
289	Enable Meter 2 Alarm	344	Disable Speech ID's Port 3
290	Enable Meter 3 Alarm	345	User DVR Record test, erase after auto playback
291	Enable Meter 4 Alarm	346	User DVR Record test, don't erase after auto playback
292	Enable Meter 5 Alarm	347	Start General Timer 1
293	Enable Meter 6 Alarm	348	Start General Timer 2
294	Enable Meter 7 Alarm	349	Start General Timer 3
295	Enable Meter 8 Alarm	350	Stop General Timer 1
296	Disable Meter 1 Alarm	351	Stop General Timer 2
297	Disable Meter 2 Alarm	352	Stop General Timer 3

<u>FN</u>	<u>Description</u>	<u>FN</u>	<u>Description</u>
353	Remote Base Power Select 1	407	Extended Logic Output 12 PULSE
354	Remote Base Power Select 2	408	Extended Logic Output 13 PULSE
355	Remote Base Power Select 3	409	Extended Logic Output 14 PULSE
356	Guest Macros ON	410	Extended Logic Output 15 PULSE
357	Guest Macros OFF	411	Extended Logic Output 16 PULSE
358	Receiver 1 Macros ON or Enabled	412	Extended Logic Output 17 PULSE
359	Receiver 2 Macros ON or Enabled	413	Extended Logic Output 18 PULSE
360	Receiver 3 Macros ON or Enabled	414	Extended Logic Output 19 PULSE
361	Receiver 1 Macros OFF or Disabled	415	Extended Logic Output 20 PULSE
362	Receiver 2 Macros OFF or Disabled	416	Extended Logic Output 21 PULSE
363	Receiver 3 Macros OFF or Disabled	417	Extended Logic Output 22 PULSE
364	Extended Logic Output 1 ON	418	Extended Logic Output 23 PULSE
365	Extended Logic Output 2 ON	419	Extended Logic Output 24 PULSE
366	Extended Logic Output 3 ON	420	Extended Logic Output 25 PULSE
367	Extended Logic Output 4 ON	421	Extended Logic Output 26 PULSE
368	Extended Logic Output 5 ON	422	Extended Logic Output 27 PULSE
369	Extended Logic Output 6 ON	423	Extended Logic Output 28 PULSE
370	Extended Logic Output 7 ON	424	Extended Logic Output 29 PULSE
371	Extended Logic Output 8 ON	425	Extended Logic Output 30 PULSE
372	Extended Logic Output 9 ON	426	Extended Logic Output 31 PULSE
373	Extended Logic Output 10 ON	427	Extended Logic Output 32 PULSE
374	Extended Logic Output 11 ON	428	Extended Logic Output 1 OFF
375	Extended Logic Output 12 ON	429	Extended Logic Output 2 OFF
376	Extended Logic Output 13 ON	430	Extended Logic Output 3 OFF
377	Extended Logic Output 14 ON	431	Extended Logic Output 4 OFF
378	Extended Logic Output 15 ON	432	Extended Logic Output 5 OFF
379	Extended Logic Output 16 ON	433	Extended Logic Output 6 OFF
380	Extended Logic Output 17 ON	434	Extended Logic Output 7 OFF
381	Extended Logic Output 18 ON	435	Extended Logic Output 8 OFF
382	Extended Logic Output 19 ON	436	Extended Logic Output 9 OFF
383	Extended Logic Output 20 ON	437	Extended Logic Output 10 OFF
384	Extended Logic Output 21 ON	438	Extended Logic Output 11 OFF
385	Extended Logic Output 22 ON	439	Extended Logic Output 12 OFF
386	Extended Logic Output 23 ON	440	Extended Logic Output 13 OFF
387	Extended Logic Output 24 ON	441	Extended Logic Output 14 OFF
388	Extended Logic Output 25 ON	442	Extended Logic Output 15 OFF
389	Extended Logic Output 26 ON	443	Extended Logic Output 16 OFF
390	Extended Logic Output 27 ON	444	Extended Logic Output 17 OFF
391	Extended Logic Output 28 ON	445	Extended Logic Output 18 OFF
392	Extended Logic Output 29 ON	446	Extended Logic Output 19 OFF
393	Extended Logic Output 30 ON	447	Extended Logic Output 20 OFF
394	Extended Logic Output 31 ON	448	Extended Logic Output 21 OFF
395	Extended Logic Output 32 ON	449	Extended Logic Output 22 OFF
396	Extended Logic Output 1 PULSE	450	Extended Logic Output 23 OFF
397	Extended Logic Output 2 PULSE	451	Extended Logic Output 24 OFF
398	Extended Logic Output 3 PULSE	452	Extended Logic Output 25 OFF
399	Extended Logic Output 4 PULSE	453	Extended Logic Output 26 OFF
400	Extended Logic Output 5 PULSE	454	Extended Logic Output 27 OFF
401	Extended Logic Output 6 PULSE	455	Extended Logic Output 28 OFF
402	Extended Logic Output 7 PULSE	456	Extended Logic Output 29 OFF
403	Extended Logic Output 8 PULSE	457	Extended Logic Output 30 OFF
404	Extended Logic Output 9 PULSE	458	Extended Logic Output 31 OFF
405	Extended Logic Output 10 PULSE	459	Extended Logic Output 32 OFF
406	Extended Logic Output 11 PULSE		

<u>FN</u>	<u>Description</u>	<u>FN</u>	<u>Description</u>
460	Play Message Macro 41	515	Remote Base Memory 35
461	Play Message Macro 42	516	Remote Base Memory 36
462	Play Message Macro 43	517	Remote Base Memory 37
463	Play Message Macro 44	518	Remote Base Memory 38
464	Play Message Macro 45	519	Remote Base Memory 39
465	Play Message Macro 46	520	Remote Base Memory 40
466	Play Message Macro 47	521	Send DTMF Memory 21
467	Play Message Macro 48	522	Send DTMF Memory 22
468	Play Message Macro 49	523	Send DTMF Memory 23
469	Play Message Macro 50	524	Send DTMF Memory 24
470	Play Message Macro 51	525	Send DTMF Memory 25
471	Play Message Macro 52	526	Send DTMF Memory 26
472	Play Message Macro 53	527	Send DTMF Memory 27
473	Play Message Macro 54	528	Send DTMF Memory 28
474	Play Message Macro 55	529	Send DTMF Memory 29
475	Play Message Macro 56	530	Send DTMF Memory 30
476	Play Message Macro 57	531	Send DTMF Memory 31
477	Play Message Macro 58	532	Send DTMF Memory 32
478	Play Message Macro 59	533	Send DTMF Memory 33
479	Play Message Macro 60	534	Send DTMF Memory 34
480	Play Message Macro 61	535	Send DTMF Memory 35
481	Play Message Macro 62	536	Send DTMF Memory 36
482	Play Message Macro 63	537	Send DTMF Memory 37
483	Play Message Macro 64	538	Send DTMF Memory 38
484	Play Message Macro 65	539	Send DTMF Memory 39
485	Play Message Macro 66	540	Send DTMF Memory 40
486	Play Message Macro 67	541	Send DTMF Memory 41
487	Play Message Macro 68	542	Send DTMF Memory 42
488	Play Message Macro 69	543	Send DTMF Memory 43
489	Play Message Macro 70	544	Send DTMF Memory 44
490	Remote Base Memory 11	545	Send DTMF Memory 45
491	Remote Base Memory 12	546	Send DTMF Memory 46
492	Remote Base Memory 13	547	Send DTMF Memory 47
493	Remote Base Memory 14	548	Send DTMF Memory 48
494	Remote Base Memory 15	549	Send DTMF Memory 49
495	Remote Base Memory 16	550	Send DTMF Memory 50
496	Remote Base Memory 17	551	Load RTC Date & Time into RC210 Onboard Clock/Calendar
498	Remote Base Memory 19	552	CTCSS During ID ON
499	Remote Base Memory 20	553	CTCSS During ID OFF
500	Remote Base Memory 21	554	Port 1 Amount of time transmitter has been active
501	Remote Base Memory 22	555	Port 2 Amount of time transmitter has been active
502	Remote Base Memory 23	556	Port 3 Amount of time transmitter has been active
503	Remote Base Memory 24	557	Reset Port 1 Activity Timer to 0
504	Remote Base Memory 25	558	Reset Port 2 Activity Timer to 0
505	Remote Base Memory 26	559	Reset Port 3 Activity Timer to 0
506	Remote Base Memory 27	560	Give RSSI report
507	Remote Base Memory 28	561	Restart controller (same as cycling power)
508	Remote Base Memory 29	562	Port 1 Number of Keyups since last reset
509	Remote Base Memory 30	563	Port 2 Number of Keyups since last reset
510	NOT USED	564	Port 3 Number of Keyups since last reset
511	Remote Base Memory 31	565	Reset Port 1 Keyup Counter to 0
512	Remote Base Memory 32	566	Reset Port 2 Keyup Counter to 0
513	Remote Base Memory 33	567	Reset Port 3 Keyup Counter to 0
514	Remote Base Memory 34	568	Reserved for future use

FN	Description		
569	Reserved for future use	621	Port 1 Hangtimer 1 Select
570	Readback A/D Channel 1 Stored Low	622	Port 1 Hangtimer 2 Select
571	Readback A/D Channel 2 Stored Low	623	Port 1 Hangtimer 3 Select
572	Readback A/D Channel 3 Stored Low	624	Port 2 Hangtimer 1 Select
573	Readback A/D Channel 4 Stored Low	625	Port 2 Hangtimer 2 Select
574	Readback A/D Channel 5 Stored Low	626	Port 2 Hangtimer 3 Select
575	Readback A/D Channel 6 Stored Low	627	Port 3 Hangtimer 1 Select
576	Readback A/D Channel 7 Stored Low	628	Port 3 Hangtimer 2 Select
577	Readback A/D Channel 8 Stored Low	629	Port 3 Hangtimer 3 Select
578	Readback A/D Channel 1 Stored High	630-639	Port 1 Next Courtesy Tone 1-10
579	Readback A/D Channel 2 Stored High	640-649	Port 1 Following Courtesy Tone 1-10
580	Readback A/D Channel 3 Stored High	650-659	Port 2 Next Courtesy Tone 1-10
581	Readback A/D Channel 4 Stored High	660-669	Port 2 Following Courtesy Tone 1-10
582	Readback A/D Channel 5 Stored High	670-679	Port 3 Next Courtesy Tone 1-10
583	Readback A/D Channel 6 Stored High	680-689	Port 3 Following Courtesy Tone 1-10
584	Readback A/D Channel 7 Stored High	690	Reserved For Future Use
585	Readback A/D Channel 8 Stored High	691	Reserved For Future Use
586	Disable Port 1 Timeout Timer ONLY for 60 min.	692	Play Port 1 Pending ID
587	Disable Port 2 Timeout Timer ONLY for 60 min.	693	Play Port 2 Pending ID
588	Disable Port 3 Timeout Timer ONLY for 60 min.	694	Play Port 3 Pending ID
589	Enable Port 1 Timeout Timer ONLY for 60 min.	695	Interrogate Port 1 Link Status
590	Enable Port 2 Timeout Timer ONLY for 60 min.	696	Interrogate Port 2 Link Status
591	Enable Port 3 Timeout Timer ONLY for 60 min.	697	Interrogate Port 3 Link Status
592	Current wind speed & direction	700	Read Digital Temperature sensor #1
593	Current Outdoor temperature	701	Read Digital Temperature sensor #2
594	Indoor humidity	702	Read Digital Temperature sensor #3
595	Outdoor humidity	703	Read Digital Temperature sensor #4
596	Wind Speed high & direction (since Midnight)	704	Read Digital Temp #1 LOW value
597	Outdoor Temp High (since Midnight)	705	Read Digital Temp #2 LOW value
598	Outdoor Temp Low (since Midnight)	706	Read Digital Temp #3 LOW value
599	Reserved for future use	707	Read Digital Temp #4 LOW value
600	Reserved for future use	708	Enable Digital Temp backgrnd read
601	Fan TimeOut OFF	709	Disable Digital Temp backgrnd read
602	Fan Timeout Set to 1 Minute	710	Enable Stuck Tx Checking Code
603	Fan Timeout Set to 5 Minutes	711	Disable Stuck Tx Checking Code
604	Fan Timeout Set to Programmed Value	712	Tx Fan Enabled
605	Speak Current Remote Base Freq & Offset	713	Tx Fan Disabled
606	Start General Timer 4	714	Speak Total Hours RC210 run
607	Start General Timer 5	715	Read Digital Temp #1 HIGH value
608	Start General Timer 6	716	Read Digital Temp #2 HIGH value
609	Stop General Timer 4	717	Read Digital Temp #3 HIGH value
610	Stop General Timer 5	718	Read Digital Temp #4 HIGH value
611	Stop General Timer 6	719	Turn ON Linked port ID Triggering
612	Disable Port 1 Inactivity Timer	720	Turn OFF Linked port ID Triggering
613	Disable Port 2 Inactivity Timer	730	Read Digital Temp #1 PREV value
614	Disable Port 3 Inactivity Timer	731	Read Digital Temp #2 PREV value
615	Port 1 Inactivity Timer to Programmed Value	732	Read Digital Temp #3 PREV value
616	Port 2 Inactivity Timer to Programmed Value	733	Read Digital Temp #4 PREV value
617	Port 3 Inactivity Timer to Programmed Value		
618	Pause Macro Execution for 1 seconds		
619	Pause Macro Execution for 2 seconds		
620	Pause Macro Execution for 4 seconds		

810 – 849 Suspend Setpoint 1 – 40
850 – 899 Resume Setpoint 1-40

901 – 990 Call Macro 1 – 90 (**901 – 950** if external EEPROM *not* installed)

2005 UF8 ON
2006 UF8 OFF
2007 UF8 Pulse

5.40 Keyup Counter and Activity Timers

Not supported.

5.41 RSSI (signal strength) Reporting

Not supported.

5.42 Tail Messages

Name:	DTMF:	Supported:
Program a Tail Message Command Macro X = Tail message number (1 – 3) Y = Command macro to use (1 – 90)	*2110 x y	Yes
Select Which Tail Message to use X = Tail message number (1 – 3)	*2111 x	Yes
Play Tail Message based on # of tails X = # of repeater tails (1 to 254)	*2112 x	Yes
Play Tail message based on Periodic Timer X = play # of seconds after last hangtime	*1020 x	Yes

NOTE: Tail messages MUST be enabled via a Macro function to work. Look at macro functions: 309-320.

5.43 DTMF Memories

DTMF Memories 1-40 Supported. Unlocked DTMF command support is the *2105 DTMF command. Macro functions: 259-278 and 521-540 supported. DTMF memories 1-18 are supported by base RC210 board. If the RC210 has the additional 3 DS2433 memory chips installed, then support is available for DTMF memories 19-40. Once programmed, the DTMF memories can be recalled in any command macro. Select which port to send DTMF to by the same method as speech.

*2105xx y y y y y y y y y y where “xx” is the number of the DTMF memory (1-40) and “y” is up to ten DTMF digits.

5.44 DTMF Digits Duration and Time Between Digits

DTMF Memories Duration time and Delay time between parameter supported. Unlocked DTMF command support for *2106, and *2107 DTMF commands.

*2106x where “x” is the duration of each DTMF digit transmitted. Range is 1 to 255 milliseconds.

*2107x where “x” is the time between DTMF digits. Range is 1 to 255 milliseconds.

5.45 IRLP / Echolink DTMF Regeneration

Not Supported.

5.46 Scheduler

Scheduler Set-Points supported. DTMF *4001 command support and Macro functions 810-889 supported. Scheduler Set points 1-20 are supported by the base RC210. If the RC210 has the additional 3 DS2433 memory chips installed, then support is available for Scheduler Set points 21-40.

Note: Scheduler Setpoints are one-shot events that occur only once at the scheduled time.

***4001 S * DOW * MOY * Hours * Minutes * Macro**

Where:

S is the setpoint number (1-40)

DOW is the Day-Of-Week and is a single digit:

1 = Monday	6 = Saturday
2 = Tuesday	7 = Sunday
3 = Wednesday	8 = Weekdays
4 = Thursday	9 = Weekends
5 = Friday	0 = Everyday

You may alternately use 2 digits for **DOW**, and it then becomes **DOM** (Day-of-Month). The 1st digit specifies which week within a month, and the 2nd digit specifies which day of the week.

MOY is the Month-of-Year and is a single digit:

1 = January	8 = August
2 = February	9 = September
3 = March	10 = October
4 = April	11 = November
5 = May	12 = December
6 = June	0 = Every Month
7 = July	

Hours and **Minutes** are in 24-hour time format. Example: 11 23 = 11:23am or 21 05 = 9:05pm. The **Hours** digit can be set to “99” which will cause a match every hour at the specified **Minutes** setting.

Macro is the macro to be executed at the scheduled time. (1-90)

5.47 Voice IDs

Name:	DTMF:	Supported:
Initial Voice ID #1 “ddd” up to 22 ID words	*80041ddd	Yes
Initial Voice ID #2 “ddd” up to 22 ID words	*80051ddd	Yes
Initial Voice ID #3 “ddd” up to 22 ID words	*80061ddd	Yes
Pending Voice ID #1 “ddd” up to 22 ID words	*80042ddd	Yes
Pending Voice ID #2 “ddd” up to 22 ID words	*80052ddd	Yes
Pending Voice ID #3 “ddd” up to 22 ID words	*80062ddd	Yes
Playback (if unlocked) Initial Voice ID #1	AA3	Yes
Playback (if unlocked) Initial Voice ID #2	AA4	Yes
Playback (if unlocked) Initial Voice ID #3	AA5	Yes
Playback (if unlocked) Pending Voice ID #1	AA6	Yes
Playback (if unlocked) Pending Voice ID #2	AA7	Yes
Playback (if unlocked) Pending Voice ID #3	AA8	Yes

5.48 ID Extras

Name:	DTMF:	Supported:
ID Extras x = ID # of unlocked port yy – Extra message to insert: 0 – Cancel ID extras 1 – Good M/A/E before the ID 2 – Good M/A/E after the ID 3 – Time before the ID 4 – Time after the ID 5 – Good M/A/E + Time before the ID 6 – Good M/A/E + Time after the ID 7 – Good M/A/E before ID say time after ID 8 – Time before ID and Good M/A/E after ID 9 – Time + Good M/A/E after the ID 10 – Time + Good M/A/E before the ID 11 – Random rotation of 1 through 10	*8007xyy	Yes

5.49 ID Extras Special

Name:	DTMF:	Supported:
		No

5.50 Enable/Disable Voice IDs

Name:	DTMF:	Supported:
Enable Voice IDs	*80081	Yes
Disable Voice IDs	*80080	Yes

5.51 Selecting ID Timer Start

Name:	DTMF:	Supported:
ID Timer Start on PTT	*21211	
ID Timer Start on COS	*21210	

5.52 Constant ID

Name:	DTMF:	Supported:
Constant ID ON	*80091	Yes
Constant ID OFF	*80090	Yes

5.53 CW IDs

5.54 CW Speed Programming

Name:	DTMF:	Supported:
CW Speed x = speed in wpm	*8000x	Yes

5.55 CW Tone Programming

Name:	DTMF:	Supported:
CW Tone xx = 1st tone frequency in Hz. yy = 2 nd tone frequency in Hz (optional)	*8001xxyy	Yes

5.56 CW ID Programming

Name:	DTMF:	Supported:
Program CW ID #1	*8002xx-xx	Yes
Program CW ID #2	*8003xx-xx	Yes
Playback (if unlocked) CWID #1	AA1	Yes
Playback (if unlocked) CWID #2	AA2	Yes

5.57 Using the Digital Voice Recorder (DVR)

Supported.

5.58 Resetting the RC210

Name:	DTMF:	Supported:
Perform reset	*21999	Yes

5.59 Using the Yaesu DR-1X Fusion Repeater

Name:	DTMF:	Supported:
Enable DR1X startup support X = 0 for disable X = 1 for enable	*2124x	Yes

If this feature is enabled, the following will occur:

- RC210 UF7 output will be activated on startup (and left on)
- An 8 second delay will happen on startup to allow the DR-1X repeater to complete its boot up.

The UF7 output can be used to control the power to the DR-1X repeater. If a solid-state relay is connected to UF7 output, then when the RC210 controller starts up, the power to the DR-1X will also be activated. If the RC210 firmware is then restarted (using DTMF command), then the power to the DR-1X repeater will be cycled. This can be used to reset the DR-1X repeater in case of problems or *lock-up* occurrences.

NOTE: For this to work properly, the RC210 controller MUST be powered by DC power source that is independent of the DR-1X repeater!

5.60 NVM Parameters Erase/Reset

The following list of DTMF commands is unique to the Alternate RC210 firmware. They can only be issued when the radio port is unlocked. If the RTC board or the external 24LC256 eeprom board is installed, these commands will cause the *Backup* eeprom space on these board(s) to be erased and re-written too. Be careful with these commands. You can completely delete/erase your RC210 configuration!

DTMF Command:	Meaning:
*21AA0	Complete Erase of all NVM spaces (writes all to 0xFF)
*21AA1	2561/2560 MCU internal 4k eeprom space erase
*21AA2	DS2433 #1 eeprom chip erase
*21AA3	DS2433 #2 eeprom chip erase
*21AA4	DS2433 #3 eeprom chip erase
*21AA5	RTC or external eeprom board memory erase
*21AAA	Write all NVM Parameters to Factory Defaults

5.61 Startup NVM Test Results

The following list of DTMF commands is unique to the Alternate RC210 firmware. They can only be issued when the radio port is unlocked. They will give voice response results to the RC210 NVM-Eeprom power-on self-tests that were run on startup.

DTMF Command:	Meaning:
*21BB0	2561/2560 MCU 4k eeprom space validation results
*21BB1	2561/2560 MCU 4k eeprom backup space validation results
*21BB2	DS2433 #1 eeprom space validation results
*21BB3	DS2433 #1 eeprom backup space validation results
*21BB4	DS2433 #2 eeprom space validation results
*21BB5	DS2433 #2 eeprom backup space validation results
*21BB6	DS2433 #3 eeprom space validation results
*21BB7	DS2433 #3 eeprom backup space validation results

If the eeprom block's 16-bit CRC validated correctly, then it will announce **CRC GOOD**. If the CRC test failed it will announce **CRC ERROR**. If the eeprom block was recovered from its backup eeprom block, it will also announce **CRC READY**. If an eeprom block was updated from its other copy, it will announce **CRC UP**. If the selected DS2433 eeprom device is not in use, it will announce **CRC NOT ACTIVE**. If the selected DS24ee and/or its backup storage eeprom is not present, it will announce **CRC NOT PERCENT**. See the table below:

Announce Voice Results:

Result:	Voice:
CRC Correct	CRC GOOD
CRC Bad	CRC ERROR
Block Recovered	CRC READY
Block Updated	CRC UP

Block not in use	CRC NOT ACTIVE
Block not Present	CRC NOT PERCENT

5.62 Internal Firmware Debugging Information

The following list of DTMF commands is unique to the Alternate RC210 firmware. They can only be issued when the radio port is unlocked. They will give numeric voice response values that indicate various internal firmware states. This can be useful for debugging problems.

DTMF Command:	Meaning:
*21BB8	First spoken number is the HLC Queue Full counter (should be zero). Next spoken word is the number of free space in HLC queue. Next spoken word is the number of free space in DVR queue
*21BB9	Toggle On/Off the internal Transmit Watchdog “Extra” checking code. Useful if the firmware fails to turn off a radio port’s transmitter when it should have.
*21BBA	Report internal OWB Digital Temperature Sensor detection/initialization results. First number spoken is the number of devices found. Second number is the digital temperature sensor resolution being used. (9, 10, 11, or 12)
*21BBB	Report which hardware version of firmware is running. Spoken letters are shown in bold below: D2560 – Debug firmware version, RC210 rev 4.0 PCB D2561 – Debug firmware version, RC210 rev 3.5/4.1 PCB R2560 – Release firmware version, RC210 rev 4.0 PCB R2561 – Release firmware version, RC210 rev 3.5/4.1 PCB
*21BBC	Report internal task stack minimum sizes. Use *21BBCx where x is: 0 - HLCDVR Task min stack size 1 - Startup Task min stack size 2 - HLC Task min stack size 3 - Timer Task min stack size 4 - IDLE Task min stack size 5 - FreeRTOS Unallocated Heap space

5.63 Hardware Setup Supporting Commands

The following list of DTMF commands is unique to the Alternate RC210 firmware. They can only be issued when the radio port is unlocked. They are used to perform hardware setup operations, typically using a Service Monitor.

DTMF Command:	Meaning:
1555 2555 3555	Key the radio port's transmitter ON continuously. The first number (1, 2, or 3) is the desired port number to turn on the port's transmitter. No audio is generated. Any RF input (COS detection) will terminate the continuous transmit condition.
1999 2999 3999	Key up a radio port's transmitter for 5 seconds and generate a 1000 HZ test tone. The first number (1, 2, or 3) is the desired port number to turn on the port's transmitter.

5.64 Courtesy Tone Programming

Name:	DTMF:	Supported:
Courtesy Tone Delay to Segment 1 CT = courtesy tone set (01 – 10)	*31CT <delay> *<duration> *<tone1> *<tone2>*	Yes
Courtesy Tone Delay to Segment 2 CT = courtesy tone set (01 – 10)	*32CT <delay> *<duration> *<tone1> *<tone2>*	Yes
Courtesy Tone Delay to Segment 3 CT = courtesy tone set (01 – 10)	*33CT <delay> *<duration> *<tone1> *<tone2>*	Yes
Courtesy Tone Delay to Segment 4 CT = courtesy tone set (01 – 10)	*34CT <delay> *<duration> *<tone1> *<tone2>*	Yes

5.65 Programming Meter Faces – 10-bit A/D Converters

Name:	DTMF:	Supported:
Program Meter Face C = channel number (1 to 8) M = meter type (0 to 6) X1,Y1,X2,Y2 = calibration points	*2064 C * M* X1* Y1* X2* Y2*	Yes

5.66 Programming Meter Alarms

Name:	DTMF:	Supported:
Program Meter Alarm AN = Alarm Number (1 to 8) MN = Meter Number (1 to 8) AT = Alarm Type (1=Low, 2 = High) TP = Trip Point (value *100) MACRO = Command Macro to execute	*2066 AN * MN * AT * TP * MACRO *	Yes

5.67 Programming Reference Voltage

Name:	DTMF:	Supported:
Program desired reference voltage VVV = 3-digit voltage value *100	*2065 VVV	Yes

5.68 Alarm programming

5.68.1 Which Macro to Use with an Alarm

Name:	DTMF:	Supported:
For a falling transition: A# = Alarm number M# = Macro number	*2101 <A#> <M#>	Yes
For a rising transition: A# = Alarm number M# = Macro number	*2102 <A#> <M#>	Yes

5.69 Special Diagnostic DTMF Commands

The following list of DTMF commands can be used for diagnostics. Use at your own risk, as some of them can completely erase the RC210's NVM configuration parameters!

Name:	DTMF:	Supported:
Erase all NVM storage memories	*21AA0	Yes
Erase all 2561 MCU NVM storage memory	*21AA1	Yes
Erase DS2433 #1 NVM storage memory	*21AA2	Yes
Erase DS2433 #2 NVM storage memory	*21AA3	Yes
Erase DS2433 #3 NVM storage memory	*21AA4	Yes
Erase Backup NVM storage memory	*21AA5	Yes
Read RTC Firmware Version number	*21AA6	Yes
Read RC210 Firmware Version number	*21AA7	Yes
Read the number of RC210 DS2433 eeprom chips found.	*21AA8	Yes
Read internal firmware data variables to help diagnose stuck Tx problem.	*21AA9	Yes
Reset all NVM Configuration Parameters to Factory Defaults	*21AAA	Yes
Reset internal firmware state variables. Turn off all PTT/TX lines.	*21AAB	Yes
Report validation status of 2561 MCU eeprom primary block	*21BB0	Yes
Report validation status of 2561 MCU eeprom backup block	*21BB1	Yes
Report validation status of DS2433 #1 eeprom primary block	*21BB2	Yes
Report validation status of DS2433 #1 eeprom backup block	*21BB3	Yes
Report validation status of DS2433 #2 eeprom primary block	*21BB4	Yes
Report validation status of DS2433 #2 eeprom backup block	*21BB5	Yes
Report validation status of DS2433 #3 eeprom primary block	*21BB6	Yes
Report validation status of DS2433 #3 eeprom backup block	*21BB7	Yes
Report internal HLC Q space values (for firmware debugging)	*21BB8	Yes
Toggle extra transmit "watchdog" On/Off	*21BB9	Yes
Report Digital Temperature detection results	*21BBA	Yes
Report which hardware version of firmware is running	*21BBB	Yes
Report internal minimum task sizes	*21BBC	Yes
Read actual analog voltage at the MCU's analog port pin. X = 1-8 representing the analog meter face number.	*21CCCx	Yes
Report number of hours RC210 has been	*22222	Yes

running (without a reset/powerup)		
-----------------------------------	--	--

6. DTMF PRE-ACCESS CODE & RANGE DISCUSSION

When using the DTMF Pre-Access Code, the DTMF Pre-Access Range values must also be setup. The DTMF Pre-Access Range values specify the starting macro number and the last (ending) macro number that will be included in the DTMF Pre-Access Code usage.

For setting up the DTMF Pre-Access Range values, the starting decimal value can be 2-3 decimal digits. If a macro value of less than 10 is required, use a leading zero. For example, to start the range at macro number 4, use **04**, or **004**. The same applies to specifying the ending macro number.

The allowable macro range is decimal values from **1** to **255**.

To disable the DTMF Macro Pre-Access Code/Range, specify macro number values of **zero**.

7. LINKED PORTS & TRIGGERED IDS DISCUSSION

The default behavior of the RC210 firmware when radio ports are linked together is for the “linked” (or target port) to perform its normal configured ID transmissions when it is activated via the linked port. This behavior is the same as if the user was operating directly on the linked/target port. This can cause a lot of extra radio traffic, depending on how often the target radio port’s IDs are configured to be transmitted.

Starting with RC210 Firmware **v1.1.15**, this behavior is now configurable. It can be set ON (same as default behavior), or it can be set OFF. When this feature has been set to OFF, when a user operates on the linked (remote) radio port, the target radio port will not transmit its ID, but it may transmit its courtesy tone(s) and hang time, if configured for this. There are three methods available to configure this:

Firmware Macros:

719 - Enable Linked port ID Triggering
720 – Disable Linked port ID Triggering

Unlocked DTMF Commands:

***20911** – Enable Linked Port ID Triggering
***20912** – Disable Linked Port ID Triggering

RC210 Config Tool:

Check-Box option added to the **Special Codes** Screen:

Special Codes

Unlock, Lock, Terminator

Port 1 Unlock: 19532 1 to 8 characters

Port 2 Unlock: 29532 1 to 8 characters

Port 3 Unlock: 39532 1 to 8 characters

Global Lock: # 1 to 4 characters

Terminator: D single character

Save Changes Cancel Changes

Voice Command Responses

Enabled

DTMF Pad Test

Prefix: 87 1 to 5 characters

DTMF Mute Select

1st Digit

2nd Digit

Trigger IDs on Linked ports

Trigger IDs on Linked Ports

DTMF Pre-Access Code

DTMF Pre-Access Macro Range

Start Macro Num: 0

Stop Macro Num: 0 (Inclusive)

8. CONFIGURATION PARAMETER STORAGE ALLOCATION MAP

This section provides information about where the configuration parameters are stored. Depending upon the hardware version of the RC210 board, there may be different amounts of non-volatile storage available.

8.1 RC210 Hardware Version Eeprom Storage Capabilities

The table below shows how much non-volatile (eeprom) memory is available on each type of RC210 hardware Pcb.

RC210 Hardware Revision	Atmel MCU Type	Atmel MCU internal eeprom space	DS2433 Eeeprom space
3.3	ATMega128	4k bytes	None
3.3	ATMega2561	4k bytes	None
3.5(a)	ATMega2561	4k bytes	(3) x 512 bytes = 1536 bytes
4.0	ATMega2560	4k bytes	(1) x 512 bytes <i>(May not be populated = 0 bytes)</i>
4.1	ATMega2561	4k bytes	(1) x 512 bytes

Table 9 – RC210 Hardware Versions Eeprom Devices Supported

8.2 Configuration Parameter Allocation Map

The following table shows where the configuration parameters are stored. Note: if your RC210 does not have the type of eeprom storage device, then those parameters will not be available.

Configuration Parameter Name	Storage Location
DELAY Before Speech/CW	MCU eeprom
FAN Timer	MCU eeprom
GLOBAL Configuration Options	MCU eeprom
DTMF Terminator Digit	MCU eeprom
DTMF Lock Code	MCU eeprom
DTMF Test Pad Prefix	MCU eeprom
Analog Reference Voltage	MCU eeprom
Analog Meter Face 1 - 8	MCU eeprom
Meter Face Alarm 1 - 8	MCU eeprom
Alarm 1- 5	MCU eeprom
General Timer 1 - 6	MCU eeprom
Courtesy Tone 1 - 10	MCU eeprom
Radio Port Configurations 1 - 3	MCU eeprom
Macro 1 - 50	MCU eeprom
Message Macro 1 – 40	MCU eeprom
DVR Slot 1 - 30	MCU eeprom
Digital Temperature Sensor Configuration	MCU eeprom
DTMF Pre-Access Code	MCU eeprom
Scheduler Set-Points 1 – 20	MCU eeprom
DTMF Memories 1 – 18	MCU eeprom
DTMF Memory Duration/Delay	MCU eeprom
Macro 51	DS2433 #1
Message Macro 41	DS2433 #1
Macro 52	DS2433 #1
Message Macro 42	DS2433 #1
Macro 53	DS2433 #1
Message Macro 43	DS2433 #1
Macro 54	DS2433 #1
Message Macro 44	DS2433 #1
Macro 55	DS2433 #1
Message Macro 45	DS2433 #1
Macro 56	DS2433 #1
Message Macro 46	DS2433 #1
Macro 57	DS2433 #1
Message Macro 47	DS2433 #1
Macro 58	DS2433 #1
Message Macro 48	DS2433 #1
Macro 59	DS2433 #1
Message Macro 49	DS2433 #1
Macro 60	DS2433 #1
Message Macro 50	DS2433 #1
Macro 61	DS2433 #1
Message Macro 51	DS2433 #1
Macro 62	DS2433 #1

Message Macro 52	DS2433 #1
Macro 63	DS2433 #1
Message Macro 53	DS2433 #1
Macro 64	DS2433 #1
Message Macro 54	DS2433 #1
Macro 65	DS2433 #1
Message Macro 55	DS2433 #1
Macro 66	DS2433 #1
Presence Flag #1	DS2433 #1
Macro 67	DS2433 #2
Message Macro 56	DS2433 #2
Macro 68	DS2433 #2
Message Macro 57	DS2433 #2
Macro 69	DS2433 #2
Message Macro 58	DS2433 #2
Macro 70	DS2433 #2
Message Macro 59	DS2433 #2
Macro 71	DS2433 #2
Message Macro 60	DS2433 #2
Macro 72	DS2433 #2
Message Macro 61	DS2433 #2
Macro 73	DS2433 #2
Message Macro 62	DS2433 #2
Macro 74	DS2433 #2
Message Macro 63	DS2433 #2
Macro 75	DS2433 #2
Message Macro 64	DS2433 #2
Macro 76	DS2433 #2
Message Macro 65	DS2433 #2
Macro 77	DS2433 #2
Message Macro 66	DS2433 #2
Macro 78	DS2433 #2
Message Macro 67	DS2433 #2
Macro 79	DS2433 #2
Message Macro 68	DS2433 #2
Macro 80	DS2433 #2
Message Macro 69	DS2433 #2
Macro 81	DS2433 #2
Message Macro 70	DS2433 #2
Macro 82	DS2433 #2
Presence Flag #2	DS2433 #2
Macro 83 – Macro 90	DS2433 #3
Scheduler Set-Point 21 - 40	DS2433 #3
DTMF Memory 19-40	DS2433 #3
Presence Flag #3	DS2433 #3

Table 10 – Configuration Parameters Allocation Map

9. DVR VOICE VOCABULARY LIST

The RC210 alternate firmware supports the same voice vocabulary words as the standard RC210 firmware. See the next page:

000	ZERO	059	ALERT	118	FROM
001	ONE	060	ALL	119	FULL
002	TWO	061	AMATEUR	120	GET
003	THREE	062	AMPS	121	GO
004	FOUR	063	AND	122	GOOD
005	FIVE	064	ANSWER	123	HAM
006	SIX	065	APRIL	124	HELLO
007	SEVEN	066	ASSOCIATION	125	HELP
008	EIGHT	067	AT	126	HERTZ
009	NINE	068	AUGUST	127	HIGH
010	TEN	069	AUTO	128	HOLD
011	ELEVEN	070	AUTOMATIC	129	HOUR
012	TWELVE	071	AUXILARY	130	INTERNET
013	THIRTEEN	072	AVERAGE	131	INTRUDER
014	FOURTEEN	073	A.M.	132	IS
015	FIFTEEN	074	BAND	133	JANUARY
016	SIXTEEN	075	BASE	134	JULY
017	SEVENTEEN	076	BATTERY	135	JUNE
018	EIGHTEEN	077	BELOW	136	LEFT
019	NINETEEN	078	BUSY	137	LIGHT
020	TWENTY	079	BY	138	LINE
021	THIRTY	080	CALIBRATE	139	LINK
022	FOURTY	081	CALL	140	LOCK
023	FIFTY	082	CANCEL	141	LOW
024	SIXTY	083	CARRIER	142	MANUAL
025	SEVENTY	084	CAUTION	143	MARCH
026	EIGHTY	085	CHANGE	144	MAXIMUM
027	NINETY	086	CHECK	145	MAY
028	HUNDRED	087	CLEAR	146	MEETING
029	THOUSAND	088	CLOCK	147	MEGA
030	A	089	CODE	148	MESSAGES
031	B	090	COMPLETE	149	METER
032	C	091	COMPUTER	150	MILES PER HOUR
033	D	092	CONNECT	151	MINIMUM
034	E	093	CONNECTED	152	MINUS
035	F	094	CONTROL	153	MINUTES
036	G	095	CONTROLLER	154	MIX
037	H	096	CURRENT	155	MONDAY
038	I	097	DANGER	156	MONITOR
039	J	098	DATE	157	MORNING
040	K	099	DAY	158	MUTE
041	L	100	DECEMBER	159	NEGATIVE
042	M	101	DEGREES	160	NET
043	N	102	DEVIATION	161	NIGHT
044	O	103	DIRECTION	162	NO
045	P	104	DISCONNECTED	163	NORTH
046	Q	105	DOWN	164	NOT
047	R	106	EAST	165	NOVEMBER
048	S	107	ECHO	166	NUMBER
049	T	108	EMERGENCY	167	OCLOCK
050	U	109	ENTER	168	OCTOBER
051	V	110	EQUAL	169	OF
052	W	111	ERROR	170	OFF
053	X	112	EVENING	171	ON
054	Y	113	FAILURE	172	OPERATOR
055	Z	114	FEBRUARY	173	OUT
056	ABOVE	115	FEET	174	OVER
057	ACTIVE	116	FREQUENCY	175	PATCH
058	AFTERNOON	117	FRIDAY	176	PERCENT

177	PHONE	236	DVR TRACK 1
178	PLEASE	237	DVR TRACK 2
179	PLUS	238	DVR TRACK 3
180	POINT	239	DVR TRACK 4
181	PORT	240	DVR TRACK 5
182	POWER	241	DVR TRACK 6
183	PROGRAM	242	DVR TRACK 7
184	P.M.	243	DVR TRACK 8
185	RADIO	244	DVR TRACK 9
186	READY	245	DVR TRACK 10
187	RECEIVE	246	DVR TRACK 11
188	REMOTE	247	DVR TRACK 12
189	REPEAT	248	DVR TRACK 13
190	REPEATER	249	DVR TRACK 14
191	SATURDAY	250	DVR TRACK 15
192	SECONDS	251	DVR TRACK 16
193	SELECT	252	DVR TRACK 17
194	SEPTEMBER	253	DVR TRACK 18
195	SET	254	DVR TRACK 19
196	SKYWARN	255	DVR TRACK 20
197	SOUTH		
198	SQUELCH		
199	START		
200	STOP		
201	SUNDAY		
202	SYSTEM		
203	TEMPERATURE		
204	THANK YOU		
205	THE (long)		
206	THE (short)		
207	THE TIME IS		
208	THIS		
209	THURSDAY		
210	TIME		
211	TIMEOUT		
212	TIMER		
213	TODAY		
214	TOMORROW		
215	tone		
216	TONIGHT		
217	TRANSMIT		
218	TUESDAY		
219	UNDER		
220	UP		
221	USE (noun)		
222	USE (verb)		
223	VOLTAGE		
224	VOLTS		
225	WAIT		
226	WARNING		
227	WATTS		
228	WEATHER		
229	WEDNESDAY		
230	WELCOME		
231	WEST		
232	YESTERDAY		
233	ZULU		
234	S (makes plural)		
235	SILENCE (pause)		

10. FACTORY DEFAULT PROGRAMMING VALUES

When you first program the alternate firmware into your RC210, the following values are programmed as defaults:

Port Specific

Carrier/PL Access	Carrier squelch All Ports
Hang time	Port 1 – 5/5/5 seconds. Ports 2 & 3 – 0/0/0 seconds
Timeout	180 seconds All Ports
Cw Tone	Port 1 - 600 Hz. Ports 2 & 3 - 800 Hz
CW Speed	20 wpm All Ports
Monitor Mix	Yes All Ports
Port Enabled	Yes All Ports
Link to other Ports	OFF All Ports
Repeat Mode	Port 1 - Repeat, Ports 2 & 3 - Non-Repeat
Port Enabled	Yes All Ports
Receiver Enabled	Yes All Ports
DTMF Covertone	ON All Ports
Courtesy Tone	# 1 All Ports
DTMF Mute	ON All Ports
Speech Override	ON All Ports
Speech ID Override	ON All Ports

Global

Logic Output 1 - 7	Open (inactive)	Port 1 Unlock Code	15281
Alarm 1 – 5	Disabled	Port 2 Unlock Code	25281
Auxiliary Audio Inputs	OFF	Port 3 Unlock Code	35281
Analog Meter Inputs	None defined	Lock Code	#
Command Macros	None programmed	DTMF Terminator	D
Macro Recall Codes	10901 – 109090 (10901-1090105)	Autopatch HangUp	C0
Remote Base Type	Kenwood Serial Type	Autopatch Dial	C1
Fan Turn Off Time	5 minutes	Autopatch AutoDial	C2
Yaesu DR1x Startup	OFF	Autopatch Timer Extend	C3
Remote Base Prefix	A7		
Say Year	ON		
RTC Correction Factor	None		

11. LM335 ANALOG TEMPERATURE SENSOR CONNECTION

The recommended connection method for stable LM335 temperature readings is to use a 1.0 uf ceramic capacitor across the LM335 sensor output to ground. See example below:

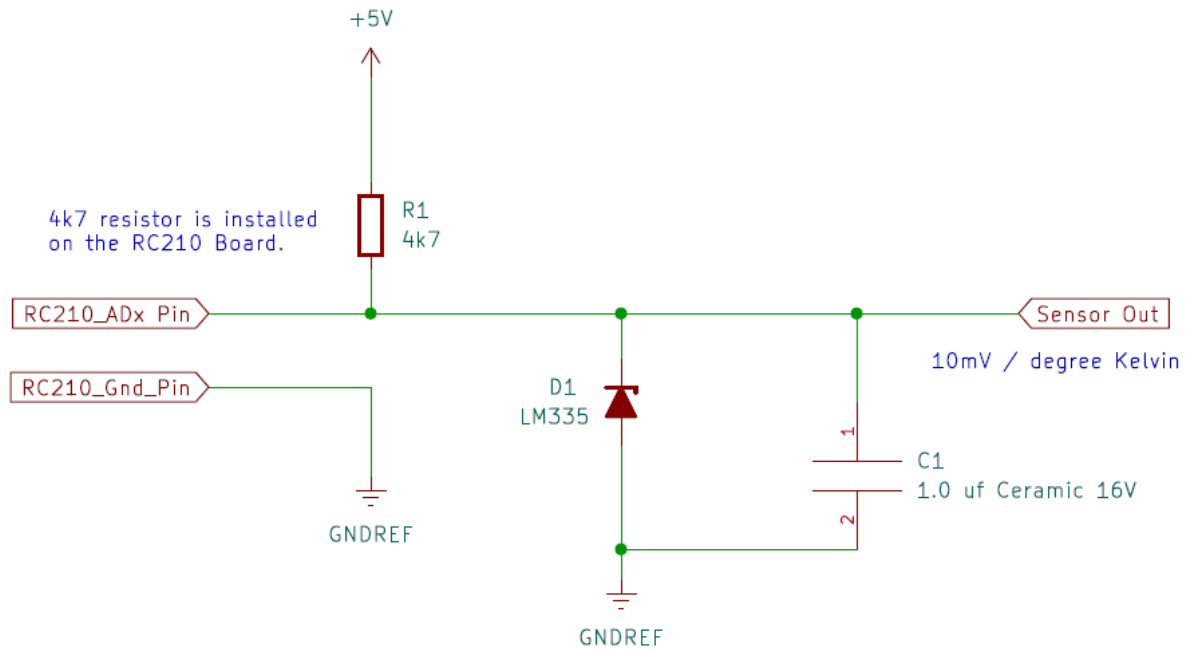

For the analog temperature sensor calibration to work, YOU MUST remove the Zener protection diode on the analog input pin. This will be diodes: D15 for DB25 input pin 1, or D13 for DB25 input pin 2. If using one of the other DB25 input pins, then the associated diode(s) to remove are: D4, D5, D7, D8, D10, and/or D11. You can easily “clip” one leg of the diode and leave the diode installed in the pcb to accomplish this.

12. DIGITAL TEMPERATURE SENSOR SUPPORT

Starting with RC210 firmware vA1.06, support has been added for using the DS18B20 and MAX31820 types of digital temperature sensors. The DS18B20 are the preferred parts to use, as they are a 5-volt part whereas the MAX31820 are 3-volt parts. NOTE: Do not use the MAX31820PAR parts, as they require an additional switching transistor in the interface circuitry that is not provided. As the DS18B20 parts are becoming harder to obtain, the MAX31820 part will become the preferred part.

These temperature sensors do not directly interface with the RC210's I/O connector. Due to the RC210's internal 470-ohm series resistor, the sensor does not see the low voltage part of the signaling waveform as low enough to meet their voltage specifications. (NOTE: It is possible to make the DS18B20/MAX31820 sensors work directly from the RC210 I/O port signal with appropriate resistors selection but viewing the waveform with a scope shows that the low voltage part of the waveform does not meet the worst-case specifications according to the DS18B20/MAX31820 datasheet.)

A custom level shifting interface PCB has been developed by VE7IHL to allow these sensors to reliably work from the RC210 I/O connector pins. A preliminary prototype has been developed and successfully tested with. See the initial hardware schematic below:

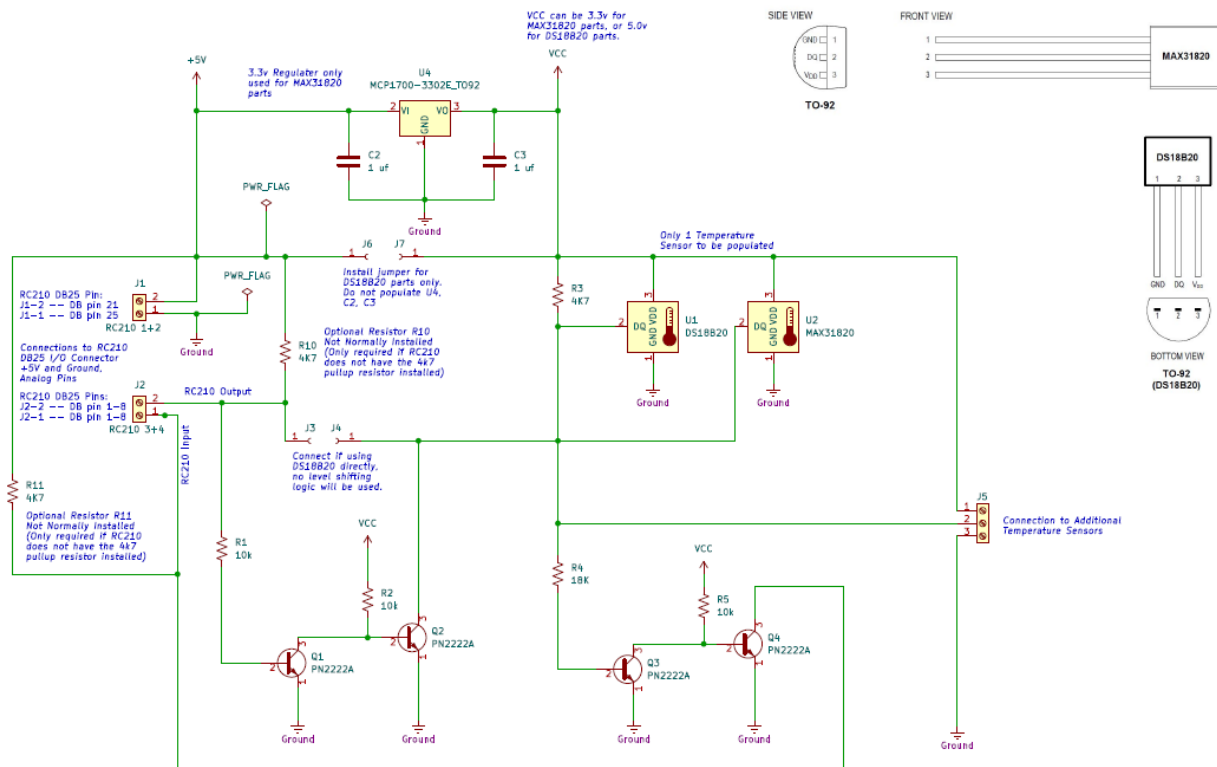

Contact VE7IHL for more information on the availability of this interface board.

As of RC210 Firmware vA1.07, any two of the eight analog RC210 I/O connector pins AD0 (pin 1) to AD7 (pin 8) can be used for connection to the digital temperature sensor interface board. When using AD1 and AD1 pins, the RC210 optional resistors R13 and R14 (4K7) will need to be installed, or the optional resistors on the interface board R10 and R11 need to be installed. (Only requires 1 set of (2) 4K7 pull-up resistors installed, not both)

12.1 Ready Made DS18B20 Temperature Sensors Available

You can purchase ready-made DS18B20 based temperature sensor from Amazon / EBay. These appear to be suitable for outside use. You will need to lengthen the interface cable, as they are typically only about 3 feet long. A package of five sensors was purchased from Amazon.ca for \$19.98 Canadian.

Link: https://www.amazon.ca/gp/product/B012C597T0/ref=ppx_yo_dt_b_asin_title_o02_s00?ie=UTF8&psc=1

Note: After testing these sensors, they may contain “clone” DS18B20 sensors, as they will sometimes give the wrong temperature reading at first, and then start to read-out what appears to be the correct temperature? It seems that most of the DS18B20 chips sold on Ebay and Amazon are clones. YMMV.

13. OPTIONAL 24LC256 EEPROM BOARD

Starting with alternate firmware version 1.15, support has been added to auto-detect, and use an optional plug-in 24LC256 eeprom board. It provides up to 32k bytes of backup eeprom memory that will be used to provide RC210 configuration parameter backup and recovery. It plugs in onto the 8 pin RC210 J7 connector, in place of the ARCOM RTC board. NOTE: You can only use one of these optional plugin boards at a time.

13.1 RC210 Hardware Modification

To use the optional eeprom plug in board, the RC210 resistor R32 must be removed, or at least have one its legs clipped so it is no longer in the circuit. This can easily be done with a small pair of wire-cutters by just cutting one leg of the resistor and leaving the R32 installed.

13.2 24LC256 Eeprom Board Schematic

